



US Energy Services, Inc.



Celebrating 45 Years as a Nationwide Energy Services Company



LED BUYERS GUIDE

Practical LED

Specification Grade Products at Value Pricing



2025

UPDATED PRODUCTS



Best Lead Times in the Industry

INDEX

Fixture Type	Page #
DECORATIVE LINEAR LEDS.....	41-42, 82
EMERGENCY.....	98-99
ENCLOSURES/ALL WEATHER.....	93
ENCLOSURES/OUTDOORS.....	56
EXIT SIGNS.....	95-97
HIGH BAYS.....	15-18, 86-87
LED C-T-C.....	53-55
LED RETROFITS.....	49-52
LED STRIP RETROFITS.....	51-52
LED UNDERCABINET.....	48
LINEAR PENDANTS.....	25-36, 78-79
LINEAR STRIP.....	84-85
LINEAR WALL.....	43-47, 94
OUTDOOR.....	57-73
OUTDOOR CEILING.....	60
OUTDOOR LANTERNS/POST TOPS.....	62-65
OUTDOOR POLE LIGHTS.....	72
OUTDOOR WALL.....	61
OUTDOOR WALLPACKS.....	71-72
RECESSED.....	74-77
RECESSED LINEAR.....	4-14, 77
RETROFIT KITS.....	88-90
SMART STRIPS.....	24
STRIPS.....	19-24
SURFACE.....	80-81
SURFACE LINEAR LEDS.....	37-40
WAL MOUNT FIXTURES.....	91-92
WRAPAROUNDS.....	83

Fixtures with LED arrays and drivers are on pages 4-73
XLLED Fixtures with replaceable LED tubes are on pages 74-94;
Exit Signs and Emergency pages 95-99

For Large Quantities, Call or Email us for a Quote



US Energy Services, Inc.

SAVE 20% - 30% On All Your LED Fixtures
For our Complete LED Buyers Guide, Please use QR Code Below.



OUR US Factories

Our **US Factories** boast the latest in computerized technology, from robots and 3D printers to large programmable brakes and presses to provide exceptional quality and fast turnaround for all your LED Fixtures. Our factories' flexibilities allow you to work with us on your exact specifications for the application. Our powder coat finishing provides cost effective color options.



OUR Products

The right LED fixture today requires the right wattage and lumen package, high color rendering LED's and diffusers to maximize efficiency. The right size and finish for the perfect look for your application, and the right warranty to lower maintenance cost. We can achieve all of this for you with our fast turnaround, value pricing, and continuing customer care.

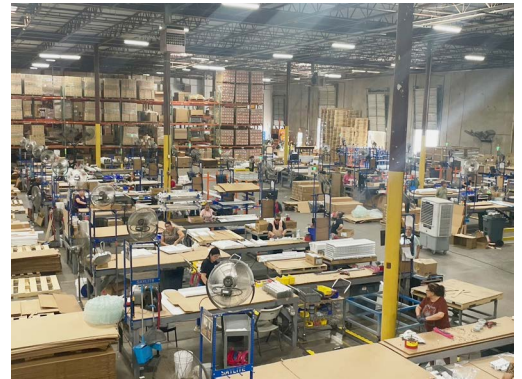

OUR Yes We Can Culture

Our founder's philosophy is to say "**Yes we can**", and then work hard to make it happen! This is a stark contrast from the slow moving, bureaucratic approach of our larger competitors. We ensure that every lighting challenge is met with determination and a smile; and we are committed to being your **BEST LIGHTING SOLUTION!**



For Large Quantities, Call or Email for Quote

US Energy Services, Inc.

Ph: 512.407.8858 • Email Info Requests and Orders to: Sales@us-energyservices.com
www.us-energyservices.com

RECESSED LINEAR

Sky Box

Our SBX is an architectural and aesthetically pleasing addition to any environment. Not only do we offer our SBX as a whole fixture; we also are able to provide a recessed shroud to transform existing flat panels in your space! This specification grade luminaire is available in 1x4, 2x2, and 2x4 sizes with 3500, 4000, or 5000K Color Temperatures. Our 2x4 boasts an offering of two different Lumen packages. The shroud can be customized to add a pop of color.



Transform your flat panel into a specification grade luminaire with our Sky Box accessory. Custom interior color makes a statement and reinforces your brand.

SKY BOX (Innovative recessed shroud and flat panels combined)

ITEM NO.	DESCRIPTION
USESXB22LED40DMVWH40	2x2 / 40W, 5000L, 4000K, 0-10V Dim, Color Temp - 35,40, 50
USESXB14LED40DMVWH40	1x4 / 40W, 5000L, 4000K, 0-10V Dim, Color Temp - 35,40, 50
USESXB24LED50DMVWH40	2x4 / 50W, 6250L, 4000K, 0-10V Dim, Color Temp - 35,40, 50



Create your own Skybox with your existing flat panel – See page 5.

US Energy Services, Inc.

Ph: 512.407.8858 • Email Info Requests and Orders to: Sales@us-energyservices.com
www.us-energyservices.com

RECESSED LINEAR



LED RECESSED TROFFER

ITEM NO.	DESCRIPTION
USE131A22LF24W2600LDMV40K*	2x2 / 24W, 2600L / Color Temp - 30, 35, 40, 50
USE131A22LF28W3000LDMV40K*	2x2 / 28W, 3000L / Color Temp - 30, 35, 40, 50
USE131A22LF35W3600LDMV40K*	2x2 / 35W, 3600L / Color Temp - 30, 35, 40, 50
USE131A14LF35W4100LDMV40K*	1x4 / 35W, 4100L / Color Temp - 30, 35, 40, 50
USE131A14LF48W5400LDMV40K*	1x4 / 48W, 5400L / Color Temp - 30, 35, 40, 50
USE131A24LF35W3650LDMV40K*	2x4 / 35W, 3650L / Color Temp - 30, 35, 40, 50
USE131A24LF45W5500LDMV40K*	2x4 / 45W, 5500L / Color Temp - 30, 35, 40, 50
USE131A24LF56W6050LDMV40K*	2x4 / 56W, 6050L / Color Temp - 30, 35, 40, 50
USE131A24LH72W8700LDMV40K*	2x4 / 72W, 8700L / Color Temp - 30, 35, 40, 50

LED RECESSED TROFFER WITH INTEGRAL OCCUPANCY SENSOR

(MICROWAVE SENSOR FOR ON/OFF CONTROL)



ITEM NO.	DESCRIPTION
USESM131A22LY28W2825LDMV40K	2x2 / 28W, 2825L / Color Temp - 30, 35, 40, 50 w/ Integral Occupancy Sensor
USESM131A14LY56W5650LDMV40K	1x4 / 56W, 5650L / Color Temp - 30, 35, 40, 50 w/ Integral Occupancy Sensor
USESM131A24LY56W5650LDMV40K	2x4 / 56W, 5650L / Color Temp - 30, 35, 40, 50 w/ Integral Occupancy Sensor

SM - Microwave Sensor, Leviton OSM3DV1W, Hidden Behind Lens

VL LED TROFFER - SPECIAL PURCHASE (WHILE QUANTITY LAST)



ITEM NO.	DESCRIPTION
USE131A24LV46W5500LDMV40K*	2x4 / 46W, 5500L / Color Temp 40
USE131A24LY56W5650LVDMV40K**	2x4 / 56W, 5650L / Color Temp - 30, 35, 40, 50

**Consult for different wattage and color temperature with programmable drivers.

Make Your Fixtures "Smarter" and More Efficient with Sensors

FOR SENSOR OPTIONS:

ADD

PREFIX DESCRIPTION

SS On / Off

SD On / Off, Daylight Harvesting

SV On / Variable Setting (DMVXX - XX is % of intensity when dim)

SM Microwave Sensor, On / Off - Consult for specific adder for your fixture.

US Energy Services, Inc.

Ph: 512.407.8858 • Email Info Requests and Orders to: Sales@us-energyservices.com

www.us-energyservices.com



FLAT PANEL LED BACK LIT (MULTI-WATTAGE, MULTI-COLOR)

ITEM NO.	DESCRIPTION
USEBLFP22LMWMLDMVMCT	LED Flat Panel 2x2 20W-2500, 30W-3750, 40W-5000 0-10V Dim, MV-ML Temp - 30, 35, 40, 50, 65K
USEBLFP14LMWMLDMVMCT	LED Flat Panel 1x4 18W-2250, 25W-3125, 35W-4375 0-10V Dim, MV-ML Temp - 35, 40, 50K
USEBLFP24LMWMLDMVMCT	LED Flat Panel 2x4 30W-3750, 40W-5000, 50W-6250, 60W-7500, 72W-9000 0-10V Dim, MV-ML Temp - 30, 35, 40, 50, 65K
USEBBEM-MV	Emergency Battery Backup, Multi Volt
USEBBEM-MV	Emergency Battery Backup, Multi Volt

For Surface Mount with Shroud - Add SH in front of item number. Integrated Sensor Available upon request
Frame-In-Kits Available to mount in hard ceilings: FIK1x4, FIK2x2, FIK2X4



FLAT PANEL LED EDGE LIT (EXTERNAL DRIVER)

ITEM NO.	DESCRIPTION
USEELFP2240W52LDMVW40K	LED Flat Panel 2x2/40W, 5270, 4000K, 0-10V Dim, Color Temp 30, 35, 40, 50K
USEELFP1440W53LDMVW40K	LED Flat Panel 1x4/40W, 5380, 4000K, 0-10V Dim, Color Temp 30, 35, 40, 50K
USEELFP2450W62LDMVW40K	LED Flat Panel 2x4/50W, 6250, 4000K, 0-10V Dim, Color Temp 30, 35, 40, 50K

Consult for different wattage and color temperature. For Emergency, add EM



SKYBOX ACCESSORY (TO USE WITH FLAT PANEL)

ITEM NO.	DESCRIPTION
USESBAFP-22	2x2 Skybox Accessory 23.95"L x 23.95"W x 3.68"H
USESBAFP-14	1x4 Skybox Accessory 47.65"L x 12"W x 3.68"H
USESBAFP-24	2x4 Skybox Accessory 47.86"L x 23.95"W x 3.68"H



Shown Surface Mount Kit with Flat Panel

SURFACE SHROUD

(SPECIALLY DESIGNED SHALLOW, CLEAN SHROUD FOR FLAT PANELS)

ITEM NO.	DESCRIPTION
USESMSHFP22WH	2x2 Surface Mount Shroud 24"L x 24"W x 3"D
USESMSHFP14WH	1x4 Surface Mount Shroud 48"L x 12"W x 3"D
USESMSHFP24WH	2x4 Surface Mount Shroud 48"L x 24"W x 3"D

Specify Flat Panel separately.

For Large Quantities, Call or Email for Quote

CENTER BASKET LED FIXTURE WITH REPLACABLE LED ARRAY

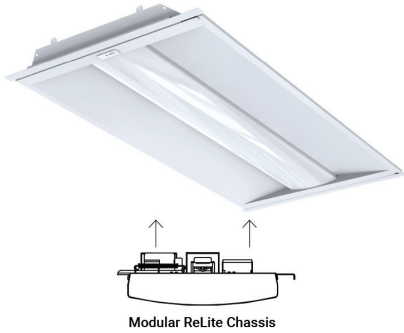

ITEM NO.	DESCRIPTION
USEMRC14US27WDMV HL=40W	1x4 27W-24W-20W-16W Selectable Wattage and Lumens 35K-4K-45K-5K HL=40W-34W-26W-20W 35K-4K-45K-5K
USEMRC22US27WDMV HL=40W	2x2 27W-24W-20W-16W Selectable Wattage and Lumens 35K-4K-45K-5K HL=40W-34W-26W-20W 35K-4K-45K-5K
USEMRC24US40WDMV HL=50W	2x4 40W-34W-26W-20W Selectable Wattage and Lumens 35K-4K-45K-5K HL=50W-45W-40W-30W 35K-4K-45K-5K
ADD MW	MICROWAVE SENSOR INSTALLED ON FIXTURE
ADD EM	EMERGENCY BATTERY BACK UP

Sustainable Fixture with Replacable Modular Chassis
Retrofit version available for 2x2 and 2x4 fixtures (See Below)

CENTER BASKET LED FIXTURE (MULTI WATTS, MULTI COLOR) LED ARRAY



ITEM NO.	DESCRIPTION
USECB2X2MWWMC	2x2 20W-2600, 30W-3900, 40W-5200 Tunable, Dimmable 3000K 3500K - 4000K - 5000K Multi Wattage Multi Color Troffer
USECB2X4MWWMC	2x4 30W-3900, 40W-5200, 50W-6500, 60W-78 Tunable, Dimmable 30K - 35K - 40K - 50K - 65K Multi Wattage Multi Color Troffer

Options Available: Bi Level Motion Sensor with Daylight Harvesting DH. ADD EM for Battery Backup

CENTER BASKET LED RETROFIT KIT WITH REPLACABLE LED ARRAY

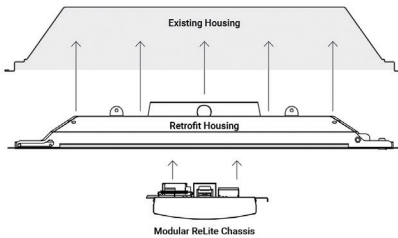

ITEM NO.	DESCRIPTION
USETRMRC14US27WD HL=40W	1x4 27W-24W-20W-16W Selectable Wattage and Lumens 35K-4K-45K-5K HL=40W-34W-26W-20W 35K-4K-45K-5K
USETRMRC22US27WD HL=40W	2x2 27W-24W-20W-16W Selectable Wattage and Lumens 35K-4K-45K-5K HL=40W-34W-26W-20W 35K-4K-45K-5K
USETRMRC24US40WD HL=50W	2x4 40W-34W-26W-20W Selectable Wattage and Lumens 35K-4K-45K-5K HL=50W-45W-40W-30W 35K-4K-45K-5K
USERDI332XLN18W40K	2x4 6300 Lumen Center Basket w/ 3 x 18W LED T8 4000K Lamps Included
ADD PIR	PASSIVE INFRARED SENSOR INSTALLED ON FIXTURE
ADD MW	MICROWAVE SENSOR INSTALLED ON FIXTURE
ADD EM	EMERGENCY BATTERY BACKUP

Sustainable Fixture with Replacable Modular Chassis

ALL CENTER BASKET FIXTURES HAVE A 5 YEAR WARRANTY



For Large Quantities, Call or Email for Quote

RECESSED LINEAR



Available with a variety of sensors. Consult for Leviton Intellect Sensor and Control System.



For additional Sensor Options see page 4.



Surface mount any recessed by adding "SH" to prefix and add \$55.

For Emergency, add EM
Consult for 1x1 and 1x2. For perforated basket change LL to PF.
For Dim to 1% up to 57watt, change DMV to D1MV



SMART LED CENTER BASKET W/ SENSOR

ITEM NO.	DESCRIPTION
USESSUCLL22LF28W3200LDMV40K	2x2 / 28W, 3200L / Color Temp - 30, 35, 40, 50
USESSUCLL22LH35W4200LDMV40K	2x2 / 35W, 4200L / Color Temp - 30, 35, 40, 50
USESSUCLL14LF30W4000LDMV40K	1x4 / 30W, 4000L / Color Temp - 30, 35, 40, 50
USESSUCLL14LF48W6000LDMV40K	1x4 / 48W, 6000L / Color Temp - 30, 35, 40, 50
USESSUCLL24LF48W6750LDMV40K	2x4 / 48W, 6750L / Color Temp - 30, 35, 40, 50
USESSUCLL24LF57W7800LDMV40K	2x4 / 57W, 7800L / Color Temp - 30, 35, 40, 50
AIR RETURN	
USESSUCRLL22LF28W3200LDMV40K	2x2 / 28W, 3200L / Color Temp - 30, 35, 40, 50
USESSUCRLL22LH35W4200LDMV40K	2x2 / 35W, 4200L / Color Temp - 30, 35, 40, 50
USESSUCRLL24LF48W6750LDMV40K	2x4 / 48W, 6750L / Color Temp - 30, 35, 40, 50
USESSUCRLL24LF57W7800LDMV40K	2x4 / 57W, 7800L / Color Temp - 30, 35, 40, 50

LED CENTER BASKET

ITEM NO.	DESCRIPTION
USEUCLL22LF28W3200LDMV40K	2x2 / 28W, 3200L / Color Temp - 30, 35, 40, 50
USEUCLL22LH35W4200LDMV40K	2x2 / 35W, 4200L / Color Temp - 30, 35, 40, 50
USEUCLL14LF30W4000LDMV40K	1x4 / 30W, 4000L / Color Temp - 30, 35, 40, 50
USEUCLL14LF48W6000LDMV40K	1x4 / 48W, 6000L / Color Temp - 30, 35, 40, 50
USEUCLL24LF48W6750LDMV40K	2x4 / 48W, 6750L / Color Temp - 30, 35, 40, 50
USEUCLL24LF57W7800LDMV40K	2x4 / 57W, 7800L / Color Temp - 30, 35, 40, 50
AIR RETURN	
USEUCRLL22LF28W3200LDMV40K	2x2 / 28W, 3200L / Color Temp - 30, 35, 40, 50
USEUCRLL22LH35W4200LDMV40K	2x2 / 35W, 4200L / Color Temp - 30, 35, 40, 50
USEUCRLL24LF48W6750LDMV40K	2x4 / 48W, 6750L / Color Temp - 30, 35, 40, 50
USEUCRLL24LF57W7800LDMV40K	2x4 / 57W, 7800L / Color Temp - 30, 35, 40, 50

VL LED CENTER BASKET

ITEM NO.	DESCRIPTION
USECBF22LV22W2700LDMV40K	2x2 / 22W, 2700L, 4000K, 0-10V Dim
USECBF22LV30W3700LDMV40K	2x2 / 30W, 3700L, 4000K, 0-10V Dim
USECBF14LV37W4500LDMV40K	1x4 / 37W, 4500L, 4000K, 0-10V Dim
USECBF14LV57W6900LDMV40K	1x4 / 57W, 6900L, 4000K, 0-10V Dim
USECBF24LV37W4500LDMV40K	2x4 / 37W, 4500L, 4000K, 0-10V Dim
USECBF24LV46W5700LDMV40K	2x4 / 46W, 5700L, 4000K, 0-10V Dim
USECBF24LV57W6900LDMV40K	2x4 / 57W, 6900L, 4000K, 0-10V Dim

LED CENTER SQUARE LENS

ITEM NO.	DESCRIPTION
USESCB22LV22W2700LDMV40K	2x2 / 22W, 2700L, 4000K, 0-10V Dim
USESCB22LV30W3700LDMV40K	2x2 / 30W, 3700L, 4000K, 0-10V Dim
USESCB14LV37W4500LDMV40K	1x4 / 37W, 4500L, 4000K, 0-10V Dim
USESCB14LV57W6900LDMV40K	1x4 / 57W, 6900L, 4000K, 0-10V Dim
USESCB24LV46W5700LDMV40K	2x4 / 46W, 5700L, 4000K, 0-10V Dim
USESCB24LV57W6900LDMV40K	2x4 / 57W, 6900L, 4000K, 0-10V Dim

US Energy Services, Inc.

Ph: 512.407.8858 • Email Info Requests and Orders to: Sales@us-energyservices.com
www.us-energyservices.com

RECESSED LINEAR

LED DECORATIVE CENTER BASKET



ITEM NO.	DESCRIPTION
USELXT22L36W3550LDMV40K	2x2 / 36W, 3550L / Color Temp 30, 35, 40, 50
USELXT24L52W5800LDMV40K*	2x4 / 52W, 5800L / Color Temp 35, 40

For Emergency, add EM

Consult for different wattage and color temperature.

LED CONCAVE LENSED



ITEM NO.	DESCRIPTION
USEVLT22L36W3200LDMV40K	2x2 / 36W, 3200L / Color Temp 30, 35, 40, 50
USEVLT24LS48W4800LDMV40K	2x4 / 48W, 4800L / Color Temp 30, 35, 40, 50
USEVLT24L52W5100LDMV40K*	2x4 / 52W, 5100L / Color Temp 35, 40

For Emergency, add EM

Consult for different wattage and color temperature.

LED CURVE LIT SIDES CENTER BASKET



Lit acrylic sides add premium look over standard Center Basket fixtures.

ITEM NO.	DESCRIPTION
USECRVRL22LS28W2700LDMV40K	2x2 / 28W, 2700L / Color Temp 30, 35, 40, 50
USECRVRL22LH35W3400LDMV40K	2x2 / 35W, 3400L / Color Temp 30, 35, 40, 50
USECRVRL24LS32W3450LDMV40K	2x4 / 32W, 3450L / Color Temp 30, 35, 40, 50
USECRVRL24LS48W4800LDMV40K	2x4 / 48W, 4800L / Color Temp 30, 35, 40, 50
USECRVRL24LS57W5400LDMV40K	2x4 / 57W, 5400L / Color Temp 30, 35, 40, 50

For Emergency, add EM for \$188.

SMART LED LINEAR RECESSED W/ SENSOR



ITEM NO.	DESCRIPTION
USESSVLT22LF24W2600LDMV40K	2 x 2 / 24W, 2600L / Color Temp - 30, 35, 40, 50
USESSVLT22LF28W3000LDMV40K	2 x 2 / 28W, 3000L / Color Temp - 30, 35, 40, 50
USESSVLT14LF35W4100LDMV40K	1 x 4 / 35W, 4100L / Color Temp - 30, 35, 40, 50
USESSVLT14LF48W5400LDMV40K	1 x 4 / 48W, 5400L / Color Temp - 30, 35, 40, 50
USESSVLT24LF35W3650LDMV40K	2x4 / 35W, 3650L / Color Temp - 30, 35, 40, 50
USESSVLT24LF48W5400LDMV40K	2x4 / 48W, 5400L / Color Temp - 30, 35, 40, 50
USESSVLT24LF56W6050LDMV40K	2x4 / 56W, 6050L / Color Temp - 30, 35, 40, 50

For additional Sensor Options see page 4. For Emergency, add EM

Smart Fixtures with Sensors are ideal for applications with irregular usage like bathrooms, closets, conference rooms and circulation spaces.

US Energy Services, Inc.

Ph: 512.407.8858 • Email Info Requests and Orders to: Sales@us-energyservices.com
www.us-energyservices.com

RECESSED LINEAR



LED DUAL BASKET

ITEM NO.	DESCRIPTION
USEUDLL22LF28W2700LDMV40K	2x2 / 28W, 2700L / Color Temp 30, 35, 40, 50
USEUDLL22LH35W3200LDMV40K	2x2 / 35W, 3200L / Color Temp 30, 35, 40, 50
USEUDLL24LF48W4800LDMV40K	2x4 / 48W, 4800L / Color Temp 30, 35, 40, 50
USEUDLL24LF57W5400LDMV40K	2x4 / 57W, 5400L / Color Temp 30, 35, 40, 50



LED RECESSED PARABOLIC

ITEM NO.	DESCRIPTION
USEPARA9C22LS24W3000LDMV40K	2 x 2 / 9 Cell / 24W, 3000L / Color Temp - 30, 35, 40, 50
USEPARA9C22LS30W3600LDMV40K	2 x 2 / 9 Cell / 30W, 3600L / Color Temp - 30, 35, 40, 50
USEPARA9C22LS42W4700LDMV40K	2 x 2 / 9 Cell / 42W, 4700L / Color Temp - 30, 35, 40, 50
USEPARA9C22LH54W6150LDMV40K	2 x 2 / 9 Cell / 54W, 6150L / Color Temp - 30, 35, 40, 50
USEPARA18C24LS48W6000LDMV40K	2 x 4 / 18 Cell / 48W, 6000L / Color Temp - 30, 35, 40, 50
USEPARA18C24LS60W7300LDMV40K	2 x 4 / 18 Cell / 60W, 7300L / Color Temp - 30, 35, 40, 50
USEPARA18C24LS85W9600LDMV40K	2 x 4 / 18 Cell / 85W, 9600L / Color Temp - 30, 35, 40, 50

Add Frosted Overlay to Hide LED's. Add FR after PARA.
For Emergency, add EM



LED PARABOLIC WHITE LOUVER (HIGH EFFICIENCY)

ITEM NO.	DESCRIPTION
USEPEW9C22LS24W3000LDMV40K	2 x 2 / 9 Cell / 24W, 3000L / Color Temp - 30, 35, 40, 50
USEPEW9C22LS30W3600LDMV40K	2 x 2 / 9 Cell / 30W, 3600L / Color Temp - 30, 35, 40, 50
USEPEW18C24LF48W6000LDMV40K	2 x 4 / 18 Cell / 48W, 6000L / Color Temp - 30, 35, 40, 50
USEPEW18C24LF60W7300LDMV40K	2 x 4 / 18 Cell / 60W, 7300L / Color Temp - 30, 35, 40, 50

Add Frosted Overlay to Hide LED's. Add FR after PEW
Consult for Louver Options. For semi-specular louver change PEW to PES. For Emergency, add EM



PERIMETER LIGHTING

ITEM NO.	DESCRIPTION
USEEWW24LS24W2400LDMV40K	Wall Wash 24 In, 24W/ 2400 Lumens; 30K,35K, 40K, 50K
USEEWW24LH35W3400LDMV40K	Wall Wash 24 In, 35W/ 400 Lumens; 30K,35K, 40K, 50K
USEEWW48LS24W2400LDMV40K	Wall Wash 48 In, 24W/ 2400 Lumens; 30K,35K, 40K, 50K
USEEWW48LS48W4800LDMV40K	Wall Wash 48 In, 48W/ 4800 Lumens; 30K,35K, 40K, 50K
USEEWW48LS57W5700LDMV40K	Wall Wash 48 In, 57W/ 5700 Lumens; 30K,35K, 40K, 50K
USEEWW48LH72W7000LDMV40K	Wall Wash 48 In, 72W/ 7000 Lumens; 30K,35K, 40K, 50K

For Emergency, add EM



RECESSED OPEN LINEAR (IDEAL FOR GENERAL MERCHANDISING)

ITEM NO.	DESCRIPTION
USEITB48LS32W4050LDMV40K	4ft. Recessed Linear 32W, 4050L/ Color Temp - 30, 35, 40, 50
USEITB48LS48W5650LDMV40K	4ft. Recessed Linear 48W, 5650L/ Color Temp - 30, 35, 40, 50
USEITB96LS48W5650LDMV40K	8ft. Recessed Linear 48W, 5650L/ Color Temp - 30, 35, 40, 50
USEITB96LS85W11000LDMV40K	8ft. Recessed Linear 85W, 11000L/ Color Temp - 30, 35, 40, 50

US Energy Services, Inc.

Ph: 512.407.8858 • Email Info Requests and Orders to: Sales@us-energyservices.com
www.us-energyservices.com



LED Lighting Solutions



US Energy Services, Inc.

**Comprehensive Line of High Efficient Sustainable LED Fixtures
The Latest LED Fixtures in the Market at Value Pricing!**



“Products & Service You Can Trust”

For Large Quantities, Call or Email for Quote

RECESSED LINEAR

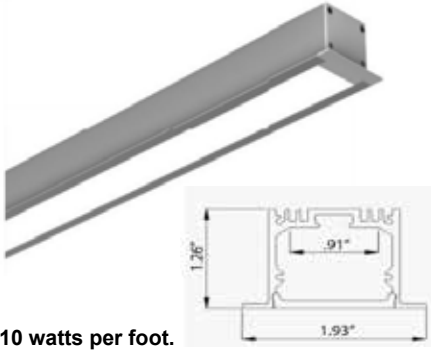

10 watts per foot.

RECESSED LINEAR 1.93" WIDTH w/FLANGE and REMOTE DRIVER

ITEM NO.	DESCRIPTION
USELLLSR47L42W2488L30KSA	47" Square 1.93" SR Channel w/lens and 2 end caps and tape 30K installed with 10' clear wire
USELLLSR96L83W4976L30KSA	96" Square 1.93" SR Channel w/lens and 2 end caps and tape 30K installed with 10' clear wire

Change 30K to 40K for 4000 color temperature. Order driver separately.

Ideal Choice for Customized Lengths. Available from Factory in Any Length at Value Pricing. Call for Pricing.

RECESSED LINEAR 2.16" w/FLANGE AND PATTERN ACCESSORIES

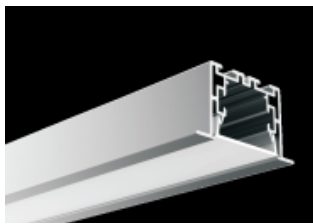

Consult for configurations and ordering.

ITEM NO.	DESCRIPTION
USELLLFR48L24W2125L30KSA	47.24" Square Recessed 2.16"W x 1.38"H FR Channel w/lens and 2 end caps and tape 30K installed with 10' clear wire
USELLLFR48L24W2125L40KSA	47.24" Square Recessed 2.16"W x 1.38"H FR Channel w/lens and 2 end caps and tape 40K installed with 10' clear wire
USELLLFR96L49W4335L30KSA	96.46" Square Recessed 2.16"W x 1.38"H FR Channel w/lens and 2 end caps and tape 30K installed with 10' clear wire
USELLLFR96L49W4335L40KSA	96.46" Square Recessed 2.16"W x 1.38"H FR Channel w/lens and 2 end caps and tape 40K installed with 10' clear wire

Configure to any 5 watts per foot shape.

LLLFR PATTERN OPTIONS

Configure recessed squares/rectangles or any pattern including up a wall and across a ceiling.

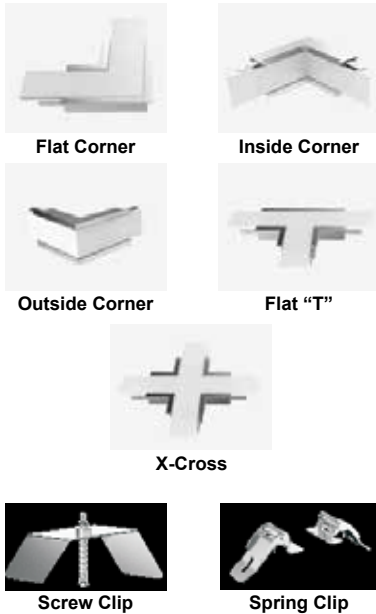

ITEM NO.	DESCRIPTION
USELLLFRJOINER	Joiner Spline for LLL FR Extrusion
USELLLFRCORNER30K	LLLFR 90 DEGREE FLAT CORNER 3000K
USELLLFRCORNER40K	LLLFR 90 DEGREE FLAT CORNER 4000K
USELLLFRIS9030K	LLLFR 90 DEGREE INSIDE CORNER 3000K
USELLLFRIS9040K	LLLFR 90 DEGREE INSIDE CORNER 4000K
USELLLFRS9030K	LLLFR 90 DEGREE OUTSIDE CORNER 3000K
USELLLFRS9040K	LLLFR 90 DEGREE OUTSIDE CORNER 4000K
USELLLFRTEE30K	LLLFR FLAT "T" 3000K
USELLLFRTEE40K	LLLFR FLAT "T" 4000K
USELLLFRXCROSS30K	LLLFR FLAT X-CROSS 3000K
USELLLFRXCROSS40K	LLLFR FLAT X-CROSS 4000K
USELLLFRRECLIP	LLLFR RECESSED SCREW CLIP
USELLLFRSPRINGCLIP	LLLFR BUTTERFLY SPRING CLIP SET(2)

REMOTE DRIVER (Dimmable with any standard MLV Triac (leading edge) control)



ITEM NO.	DESCRIPTION	Watts
USEMTIM60L24DC	Magnitude Magnetic Driver 60W 24VDC Encased	60
USEMTIM100L24DC	Magnitude Magnetic Driver 96W 24VDC Encased	96
USEMTIM150L24DC	Magnitude Magnetic Driver 150W 24VDC Encased	150

Consult for other drivers and wattages.

US Energy Services, Inc.

Ph: 512.407.8858 • Email Info Requests and Orders to: Sales@us-energyservices.com
www.us-energyservices.com

RECESSED LINEAR

Choose from three Recessed Mounting and Looks

Tbar Grid Ceiling Specify "R"

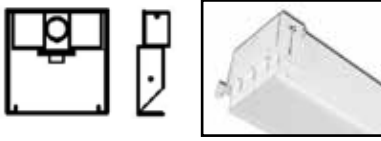

End is slightly shorter to accommodate the T Bar Grid.

Hard Ceiling - Sheetrock Flanged Version Specify "RF"

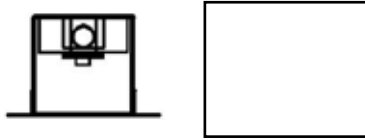

Hard Ceiling - Sheetrock Flangeless Version Specify "RRXX" or "RRPF"

XXX - Depth of Sheetrock
RRPF - Perforated Flange to mud to



New Perforated Flange 1/4" below ceiling to mud to (RRPF)

RECESSED LINEAR 2" x 3"



ITEM NO.	SIZE (W X L)	Watts / Lumens	Color Options (X100 Kelvins)
USE23RSF48LR26W2600LDMV40KWH	2" x 47.32"	26 / 2600	30, 35, 40, 50
USE23RSF48LR38W3800LDMV40KWH	2" x 47.32"	38 / 3800	30, 35, 40, 50
USE23RSF48LR45W4500LDMV40KWH	2" x 47.32"	45 / 4500	30, 35, 40, 50
USE23RSF96LR52W5200LDMV40KWH	2" x 96"	52 / 5200	30, 35, 40, 50
USE23RSF96LR76W7600LDMV40KWH	2" x 96"	76 / 7600	30, 35, 40, 50
USE23RSF96LR90W9000LDMV40KWH	2" x 96"	90 / 9000	30, 35, 40, 50

23R - Recessed for T-Bar Grid, 23RF - Flanged 23RR(XXX) - Flangeless Hard Ceiling (xxx for sheetrock depth). EM remote on 4 ft. See Specification sheet for flange option details. Remote only for emergency, add EM.
For Dim to 1% up to 57watt, change DMV to D1MV

Recessed Linear 2.5" x 3"



Shown with Flange
SES25RFSF



For sensor, add SS in front

ITEM NO.	SIZE (W X L)	Watts / Lumens	Color Options (X100 Kelvins)
USESES25RSF48LR26W2600LDMV40KWH	2.5" x 47.32"	26 / 2600	30, 35, 40, 50
USESES25RSF48LR38W3800LDMV40KWH	2.5" x 47.32"	38 / 3800	30, 35, 40, 50
USESES25RSF48LR45W4500LDMV40KWH	2.5" x 47.32"	45 / 4500	30, 35, 40, 50
USESES25RSF96LR52W5200LDMV40KWH	2.5" x 96"	52 / 5200	30, 35, 40, 50
USESES25RSF96LR76W7600LDMV40KWH	2.5" x 96"	76 / 7600	30, 35, 40, 50
USESES25RSF96LR90W9000LDMV40KWH	2.5" x 96"	90 / 9000	30, 35, 40, 50

For Sensor Option add SS in front

Dimming to 1%

Standard DMV provides dimming to 10% intensity.
For Dim to 1% up to 57watt, change DMV to D1MV

US Energy Services, Inc.

Ph: 512.407.8858 • Email Info Requests and Orders to: Sales@us-energyservices.com
www.us-energyservices.com

RECESSED LINEAR

RECESSED LINEAR 4" x 4"

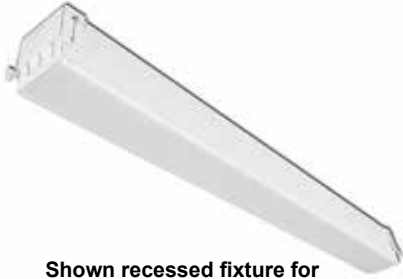

Shown recessed fixture for Tbar / Grid ceiling.

ITEM NO.	SIZE (W X L)	Watts / Lumens	Color Options (X100 Kelvins)
USE44RSF48LR24W2400LDMV40KWH	4" x 48"	24 / 2400	30, 35, 40, 50
USE44RSF48LR48W4800LDMV40KWH	4" x 48"	48 / 4800	30, 35, 40, 50
USE44RSF96LR48W4800LDMV40KWH	4" x 96"	48 / 4800	30, 35, 40, 50
USE44RSF96LR96W9600LDMV40KWH	4" x 96"	96 / 9600	30, 35, 40, 50

USE44R - For T-Bar Grid Ceiling, **44RF** - Flanged
USE44RR(XXX) - Flangeless Hard Ceiling (XXX for sheetrock depth)
 See Specification sheet for flange option details.
 For Sensor Option add SS in front
 For Dim to 1% up to 57watt, change DMV to D1MV

RECESSED LINEAR 6" x 6"



Shown "RF" recessed flange fixture.

ITEM NO.	SIZE (W X L)	Watts / Lumens	Color Options (X100 Kelvins)
USE66RSF48LR48W4800LDMV40KWH	6" x 48"	48 / 4800	30, 35, 40, 50
USE66RSF96LR48W4800LDMV40KWH	6" x 96"	48 / 4800	30, 35, 40, 50
USE66RSF96LR96W9600LDMV40KWH	6" x 96"	96 / 9600	30, 35, 40, 50

USE66R - For T-Bar Grid Ceiling, **66RF** - Flanged
USE66RR(XXX) - Flangeless Hard Ceiling (XXX for sheetrock depth)
 Blade Louver change SF to BL. To add with overlay add BLMW.
 For Regressed white Lens change SF to MW. For Sensor Option add SS in front
 For Emergency, add EM
 For Dim to 1% up to 57watt, change DMV to D1MV

Consult for 2FT and Other Customer Lengths

LINEAR RECESSED WALL WASH 4" x 4"

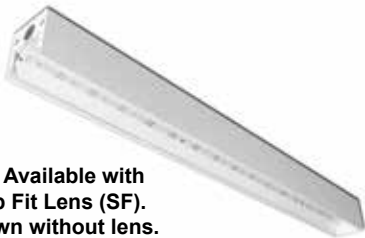

Now Available with Snap Fit Lens (SF).
 Shown without lens.
 Available in USE44 and USE66 series.

ITEM NO.	SIZE (W X L)	Watts / Lumens	Color Options (X100 Kelvins)
USE44RWSF48LRW24W2400LDMV40KWH	4" x 48"	24 / 2400	30, 35, 40, 50
USE44RWSF48LRW48W4800LDMV40KWH	4" x 48"	48 / 4800	30, 35, 40, 50
USE44RWSF96LRW48W4800LDMV40KWH	4" x 96"	48 / 4800	30, 35, 40, 50
USE44RWSF96LRW96W9600LDMV40KWH	4" x 96"	96 / 9600	30, 35, 40, 50

For Sensor Option add SS in front. For Emergency, add EM. See specification sheet or above for the flange options.
 For Dim to 1% up to 57watt, change DMV to D1MV

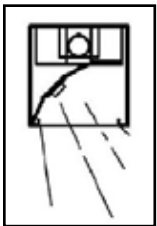

Specially designed reflector provides asymmetrical light distribution ideal for economical wall washing.

LINEAR RECESSED WALL WASH 6" x 6"

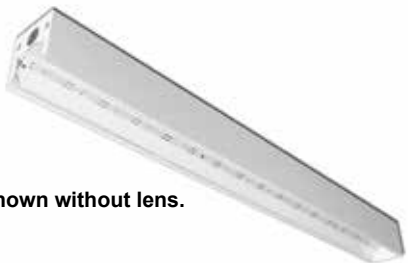

Shown without lens.

ITEM NO.	SIZE (W X L)	Watts / Lumens	Color Options (X100 Kelvins)
USE66RWSF48LRW48W4800LDMV40KWH	6" x 48"	48 / 4800	30, 35, 40, 50
USE66RWSF96LRW48W4800LDMV40KWH	6" x 96"	48 / 4800	30, 35, 40, 50
USE66RWSF96LRW96W9600LDMV40KWH	6" x 96"	96 / 9600	30, 35, 40, 50



For Sensor Option add SS in front For Emergency add EM. See specification sheet or above for the flange options.
 For Dim to 1% up to 57watt, change DMV to D1MV

US Energy Services, Inc.

Ph: 512.407.8858 • Email Info Requests and Orders to: Sales@us-energyservices.com
www.us-energyservices.com

HIGH BAYS

Evolution of a High Bay Leader (From HID to LED)

Evolution of the High Bay			
	HID	FLUORESCENT	LED
ENERGY	460 Watts	324 Watts	216 Watts
LIFE	20,000 Hours	30,000 Hours	50,000 hour
MAINTENANCE	Re-Lamp and Re-Ballast	Re-Lamp and Re-Ballast	Replace Driver

LED PREMIUM HIGH BAY w/OPTIONAL ACCESSORIES



ITEM NO.	DESCRIPTION
USEHBIP12L110W14680LMV50K*	11.8"Wx21.5"Lx2"H High Bay 110W, 14680 Lumens 50K
USEHBIP22L165W22000LMV50K*	16.0"Wx21.5"Lx2"H High Bay 165W, 22000 Lumens 50K
USEHBIP24L220W29370LMV50K*	11.8"Wx43"Lx2"H High Bay 220W 29370 Lumens 50K

For Emergency, add EM. For Occupancy Sensor, add MDT4 Fixtures include chain kits. Consult for different wattage, color temperature, and higher lumens.



HIGH OUTPUT PREMIUM LED HIGH BAY

ITEM NO.	DESCRIPTION
USEHBIHO24L245W34300LM23DMV50K*	20"Wx43"Lx1.5"H High Output High Bay 245W, 34300 LUMEN 50K
USEHBIHO24L325W45500LM23DMV50K*	20"Wx43"Lx1.5"H High Output High Bay 325W, 45500 LUMEN 50K

Consult for 200W.

ACCESSORIES

Fine tune your High Bay to your application.



Door Frame Lens options.

ITEM NO.	DESCRIPTION
USEHBI12DFMW	1x2** High Bay Door Frame Set w/ Matte White Lens
USEHBI22DFMW	2x2** High Bay Door Frame Set w/ Matte White Lens
USEHBI24DFMW	2x4** High Bay Door Frame Set w/ Matte White Lens
USEHBI12WG	1x2 Wire Guard White
USEHBI22WG	2x2 Wire Guard White
USEHBI24WG	2x4 Wire Guard White
USEHBIFMK	Flush Mounting Kit 6"L x 2"W x 0.8"H
USEHBIPDMK	Pendant Mounting Kit 3.4"L x 2.3"W x 2"H

HIGH BAYS



For lensed version
add FR after HIL.



LED HIGH BAY (OPTIONAL LENS)

ITEM NO.	DESCRIPTION
USEHIL24LT80W10000LDMV50K	24"L 80W AND 10,000 LUMENS 50K
USEHIL24LY122W15000LDMV50K	24"L 122W AND 15,000 LUMENS 50K
USEHIL48LT80W10000LDMV50K	45"L 80W AND 10,000 LUMENS 50K
USEHIL48LY122W15000LDMV50K	45"L 122W AND 15,000 LUMENS 50K
USEHIL48LA149W20000LDMV50K	45"L 149W AND 20,000 LUMENS 50K
USEHIL48LA175W25000LDMV50K	45"L 175W AND 25,000 LUMENS 50K
USEHIL48LA215W30000LDMV50K	45"L 215W AND 30,000 LUMENS 50K
USEHIL48LA260W35000LDMV50K	45"L 260W AND 35,000 LUMENS 50K
USEHIL48LA280W40000LDMV50K	45"L 280W AND 40,000 LUMENS 50K
USEHIL48LA315W45000LDMV50K	45"L 315W AND 45,000 LUMENS 50K
USEHIL48LA355W50000LDMV50K	45"L 335W AND 50,000 LUMENS 50K

Available in 3000K, 3500K and 4000K. For Frosted Lens add "FR" after HIL
For Clear Lens change FR to CL. For Wireguard add WG after FR
For Occupancy Sensor on End add MDT4
For Emergency, add EM

UPLIGHT ACCESSORY FOR HIL

ITEM NO.	DESCRIPTION
USEUV45W	Uplight Accessory Module 45W and 5500 Lumens to either 2x2 or 2x4

LED Arrays don't provide the 360 degrees light output of fluorescent lamps. For applications that require uplight, this accessory is ideal. Consult for other wattages and lumens.

HIGH BAY WITH AIMABLE AND MODULAR ARRAYS

ITEM NO.	DESCRIPTION
USEHBG48LA175W25000LW30DMV50K	20"Wx46"L / 175W, 25000L Color Temp 30, 35, 40, 50
USEHBG48LA215W30000LW30DMV50K	20"Wx46"L / 215W, 30000L Color Temp 30, 35, 40, 50
USEHBG48LA260W35000LW30DMV50K	20"Wx46"L / 260W, 35000L Color Temp 30, 35, 40, 50
USEHBG48LA280W40000LW30DMV50K	20"Wx46"L / 280W, 40000L Color Temp 30, 35, 40, 50
USEHBG48LA315W45000LW30DMV50K	20"Wx46"L / 315W, 45000L Color Temp 30, 35, 40, 50
USEHBG48LA355W50000LW30DMV50K	20"Wx46"L / 355W, 50000L Color Temp 30, 35, 40, 50

with SENSOR

USESSHBG48LA175W25000LW30DMV50K	20"Wx46"L / 175W, 25000L Color Temp 30, 35, 40, 50
USESSHBG48LA215W30000LW30DMV50K	20"Wx46"L / 215W, 30000L Color Temp 30, 35, 40, 50
USESSHBG48LA260W35000LW30DMV50K	20"Wx46"L / 260W, 35000L Color Temp 30, 35, 40, 50
USESSHBG48LA280W40000LW30DMV50K	20"Wx46"L / 280W, 40000L Color Temp 30, 35, 40, 50
USESSHBG48LA315W45000LW30DMV50K	20"Wx46"L / 315W, 45000L Color Temp 30, 35, 40, 50
USESSHBG48LA355W50000LW30DMV50K	20"Wx46"L / 355W, 50000L Color Temp 30, 35, 40, 50

Add "FR" after HBG for Frosted Lens

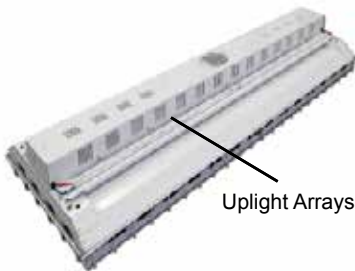

Uplight Arrays



Shown with Sensor.

Each of the Four Linear LEDs
are Separately Enclosed and
Aimable.

Consult for 2 Row Version.

The Next Generation
of High Bays is Here!

US Energy Services, Inc.

Ph: 512.407.8858 • Email Info Requests and Orders to: Sales@us-energyservices.com
www.us-energyservices.com

HIGH BAYS



See Accessories & Options Below

HIGH BAY (Most Popular High Bay Style for 6 Years)

ITEM NO.	DESCRIPTION
USEHBC48LN127W18000LA10DMV50K*	16"Wx48"L / 127W, 18000L Color Temp 30, 35, 40, 50
USEHBC48LN162W24000LA10DMV50K*	16"Wx48"L / 162W, 24000L Color Temp 30, 35, 40, 50
USEHBC48LN216W30000LA10DMV50K*	16"Wx48"L / 216W, 30000L Color Temp 30, 35, 40, 50
USEHBC48LN272W36000LA10DMV50K*	16"Wx48"L / 272W, 36000L Color Temp 30, 35, 40, 50

Some Options an Accessories shown below. Consult for other wattage and lumen packages.

LOW BAY



ITEM NO.	DESCRIPTION
USEHBC48LS61W7040LW30DMV40K	10"Wx48"L / 61W, 6450L Color Temp 30, 35, 40, 50
USEHBC48LF97W11300LW30DMV40K*	16"Wx48"L / 97W, 11300L Color Temp 30, 35, 40, 50
USEHBC48LH118W13500LW30DMV50K*	16"Wx48"L / 118W, 13500L Color Temp 30, 35, 40, 50

LENS AND DOOR FRAME OPTIONS

(See Width Description Above for Correct Version)

	USEHBC10"	USEHBC16"
Clear Lens Wraps Around Body	USEHBC10CL	USEHBC16CL
Frosted Lens Wraps Around Body	USEHBC10FR	USEHBC16FR
Door Frame with Clear Lens*	DFCL	DFCL
Door Frame with Frosted Lens*-	DFFR	DFFR

Add Wire Guard without door with WG at end of item number

Consult for Door Frame and Lens.

AISLE LIGHT



Shown with Optional Wire Guard

ITEM NO.	DESCRIPTION
4FT	
USEHBCA48LN110W16000LA10DMV50K	8"Wx48"L / 110W, 16000L Color Temp 30, 35, 40, 50
USEHBCA48LN144W20000LA10DMV50K	8"Wx48"L / 144W, 20000L Color Temp 30, 35, 40, 50
8FT	
USEHBCA96LN162W24000LA10DMV50K	8"Wx96"L / 162W, 24000L Color Temp 30, 35, 40, 50
USEHBCA96LN220W32000LA10DMV50K	8"Wx96"L / 220W, 32000L Color Temp 30, 35, 40, 50
USEHBCA96LN288W40000LA10DMV50K	8"Wx96"L / 288W, 40000L Color Temp 30, 35, 40, 50

For Wire Guard Add WG. Consult for other wattage and lumen packages.

MINI HIGH BAY



Shown with Door Frame and Lens

ITEM NO.	DESCRIPTION
USEHBC22LN63W9000LA10DMV50K	20"Wx24"L / 63W, 9000L Color Temp 30, 35, 40, 50
USEHBC22LZ110W16000LA10DMV50K	20"Wx24"L / 110W, 16000L Color Temp 30, 35, 40, 50
USEHBC22LZ144W20000LA10DMV50K	20"Wx24"L / 144W, 20000L Color Temp 30, 35, 40, 50

For Door Frame and Lens add DFFR and \$40

HIGH BAY ACCESSORY OPTIONS



USEGT310

USEMDT4
for sensor



ITEM NO.	DESCRIPTION
USEMDT4	External Mounted Occupancy Sensor
USEWG	Wire Guard for HBC Full Size
USEGT310	Gripple Style Cable Kit 10 FT
USEHC101	Chain Kit - 4 "S" Hooks & 20 FT Chain
USEEM	Emergency Driver
USEHBC7	Center Hub for 3/4" Pipe

US Energy Services, Inc.

Ph: 512.407.8858 • Email Info Requests and Orders to: Sales@us-energyservices.com

www.us-energyservices.com

HIGH BAYS



Consult for Acrylic Reflectors.



For Low Bay change Cone to LB



LED ENCLOSED HIGH BAY

ITEM NO.	DESCRIPTION
USELHB60WMV50KCONE	60W MV 4650L 50K 90° REF, 19" Dia x 7.5"H
USELHB60WMV50KDOME	60W MV 4650L 50K 45° REF, 16.5" Dia x 10"H
USELHB100WMV50KCONE	100W MV 10,000L 50K 90° REF, 19" Dia x 7.5"H
USELHB100WMV50KDOME	100W MV 10,000L 50K 45° REF, 16.5" Dia x 10"H
USELHB150WMV50KCONE	150W MV 13,500L 50K 90° REF, 19" Dia x 7.5"H
USELHB150WMV50KDOME	150W MV 13,500L 50K 45° REF, 16.5" Dia x 10"H
USELHB200WMV50KCONE	200W MV 19,350L 50K 90° REF, 19" Dia x 7.5"H
USELHB200WMV50KDOME	200W MV 19,350L 50K 45° REF, 16.5" Dia x 10"H

For Acrylic Frosted Dome, add FR or Acrylic Clear Dome, add CR at end of item number.

VAPOR TIGHT HIGH BAY WET LOCATION

(IDEAL FOR COLD STORAGE AND WASH DOWN) IP65, IP66 IP67, NEMA 4X



ITEM NO.	DESCRIPTION
USECITACL48LV80W8730LDMV50K	51.91"L x 14.61"W x 5.8"H Clear with Frosted Ends Lens 80W / 8730L
USECITACL48LV100W11100LDMV50K	51.91"L x 14.61"W x 5.8"H Clear with Frosted Ends Lens 100W / 11100L
USECITACL48LA120W13350LDMV50K	51.91"L x 14.61"W x 5.8"H Clear with Frosted Ends Lens 120W / 13350L
USECITACL48LA140W15550LDMV50K	51.91"L x 14.61"W x 5.8"H Clear with Frosted Ends Lens 140W / 15550L
USECITACL48LA150W16500LDMV50K	51.91"L x 14.61"W x 5.8"H Clear with Frosted Ends Lens 150W / 16500L
USECITACL48LA180W19000LDMV50K	51.91"L x 14.61"W x 5.8"H Clear with Frosted Ends Lens 180W / 20000L

For Emergency, add EM. See specification sheet for mounting options and accessories. CL is Clear Acrylic Lens, change to FR for Frosted Acrylic Lens. For Polycarbonate Versions add PC after CL or FR. Available in 3000K, 3500K and 4000K.

VAPOR TIGHT LOW BAY WET LOCATION

(IDEAL FOR COLD STORAGE AND WASH DOWN) IP65, IP66 IP67, NEMA 4X



ITEM NO.	DESCRIPTION
USECITACL24LV80W8000LDMV50K	26.6"L x 14.5"W x 5.8"H, Clear with Frosted Ends Lens 80W / 8000L
USECITACL24LV100W10000LDMV50K	26.6"L x 14.5"W x 5.8"H, Clear with Frosted Ends Lens 100W / 10000L
USECITACL24LV140W14000LDMV50K	26.6"L x 14.5"W x 5.8"H, Clear with Frosted Ends Lens 140W / 14000L

For Emergency, add EM. See specification sheet for mounting options and accessories. CL is Clear Acrylic Lens, change to FR for Frosted Acrylic Lens. For Polycarbonate Versions add PC after CL or FR. Available in 3000K, 3500K and 4000K.

US Energy Services, Inc.

Ph: 512.407.8858 • Email Info Requests and Orders to: Sales@us-energyservices.com
www.us-energyservices.com

STRIPS

Industrial Strips Your Choice for Industrial Lighting with LED.

LED Industrials provide more light on the cartons on each side of the aisle.



INDUSTRIAL STRIP FAMILY (1 STYLE, 3 CONFIGURATIONS)

ITEM NO.	DESCRIPTION
Enclosed with Hinged Frosted Lens	
USERRSFR48LE28W2700LDMV40K	48" Enclosed w/ FR Hinged Lens 28W/ 2700L
USERRSFR48LE48W4600LDMV40K	48" Enclosed w/ FR Hinged Lens 48W/ 4600L
USERRSFR48LE57W5400LDMV40K	48" Enclosed w/ FR Hinged Lens 57W/ 5400L
USERRSFR96LE57W5400LDMV40K	96" Enclosed w/ FR Hinged Lens 57W/ 5400L
USERRSFR96LE96W9200LDMV40K	96" Enclosed w/ FR Hinged Lens 96W/ 9200L
USERRSFR96LE114W10400LDMV40K	96" Enclosed w/ FR Hinged Lens 114W/ 10400L
Deep Enhanced White Reflector	
USERRS48LE28W3400LW30DMV40K	48" with White Reflector 28W / 3400
USERRS48LE48W5650LW30DMV40K	48" with White Reflector 48W / 5650
USERRS48LE57W6400LW30DMV40K	48" with White Reflector 57W / 6400
USERRS96LE57W6400LW30DMV40K	96" with White Reflector 57W/ 6400
USERRS96LE96W11300LW30DMV40K	96" with White Reflector 96W/ 1300L
USERRS96LE114W12800LW30DMV40K	96" with White Reflector 14W/ 12800L
Open Strip	
USERRS48LE28W3950LDMV40K	48" Open 28W /3950L
USERRS48LE48W6000LDMV40K	48" Open 48W /6000L
USERRS48LE57W6900LDMV40K	48" Open 57W /6900L
USERRS96LE57W6900LDMV40K	96" Open 57W /6900L
USERRS96LE96W12000LDMV40K	96" Open 96W /12000L
USERRS96LE114W13800LDMV40K	96" Open 114W /13800L

Available in 3000K, 3500K and 5000K. For Emergency, add EM. Consult for other sizes.



INDUSTRIAL LED (IDEAL FOR CEILINGS BETWEEN 10 AND 18 FEET)



ITEM NO.	SIZE (W X L)	Watts / Lumens	Color Options (X100 Kelvins)
USEIND48LS32W4050LW30DMV40K	10" x 48"	32 / 4050	30, 35, 40, 50
USEIND48LS48W5650LW30DMV40K	10" x 48"	48 / 5650	30, 35, 40, 50
USEIND48LS57W6400LW30DMV40K	10" x 48"	57 / 6400	30, 35, 40, 50
USEIND96LS48W5650LW30DMV40K	10" x 96"	48 / 5650	30, 35, 40, 50
USEIND96LS97W11300LW30DMV40K	10" x 96"	97 / 11300	30, 35, 40, 50
USEIND96LS114W12800LW30DMV40	10" x 96"	114 / 12800	30, 35, 40, 50

For Emergency, add EM. Add wire guard IND48WGWH

For continuous run applications add wiring harnesses for electrical plug and play, see Page 27

ECONOMY LENSED STRIP (IDEAL FOR COVE LIGHTING)



ITEM NO.	SIZE (W X L)	Watts / Lumens	Color Options (X100 Kelvins)
USERKDFR24LE12W1200LDMV40KWH	2" x 24"	12 / 1200	30, 35, 40, 50
USERKDFR24LH24W2600LDMV40KWH	2" x 24"	24 / 2600	30, 35, 40, 50
USERKDFR48LE28W2900LDMV40KWH	2" x 46"	28 / 2900	30, 35, 40, 50
USERKDFR48LH35W4100LDMV40KWH	2" x 46"	35 / 4100	30, 35, 40, 50
USERKDFR48LH48W5100LDMV40KWH	2" x 46"	48 / 5100	30, 35, 40, 50
USERKDFR96LE57W5900LDMV30KWH	2" x 92"	57 / 5900	30, 35, 40, 50
USERKDFR96LH72W8200LDMV40KWH	2" x 92"	72 / 8200	30, 35, 40, 50
USERKDFR96LH96W10200LDMV40KWH	2" x 92"	96 / 10200	30, 35, 40, 50

For Continuous runs add PI1 or PI3D after DMV for Electrical Connector.
For Emergency, add EM.

LINEAR STRIP WORKHORSE (IDEAL FOR CONTINUOUS RUNS)



Pendant mount available. Available in 3000K, 3500K, and 5000K.

ITEM NO.	DESCRIPTION
USEFSFFR48LF31W3100LDMV40KWH	2.36"W x 47.25"L x 2.83"H / 31W, 3100L, 4000K
USEFSFFR48LF57W5900LDMV40KWH	2.36"W x 47.25"L x 2.83"H / 57W, 5900L, 4000K
USEFSFFR96LF62W6200LDMV40KWH	2.36"W x 94.43"L x 2.83"H / 62W, 6200L, 4000K
USEFSFFR96LF114W11700LDMV40KWH	2.36"W x 94.43"L x 2.83"H / 114W, 11700L, 4000K

For Sensor Option add SM in front or MDT4. See Retrofit Kit on page 88.
For Emergency, add EM

For continuous run applications add wiring harnesses for electrical plug and play, see Page 27

LINEAR STRIP (IDEAL REPLACEMENT FOR FLUORESCENT STRIPS)



One lens for 8 foot for great look.



ITEM NO.	DESCRIPTION
USEJSR48L40W5400LDMV40K*	42.44"L x 3.75"H x 3.25"W / 40W, 5400L, 4000K
USEJSR96L68W9400LDMV40K*	90.47"L x 3.75"H x 3.25"W / 68W, 9400L, 4000K

Change 40K to 35K or 50K. For Emergency, add EM

STRIPS

LED Designer Strips Ideal for All Applications

Dress up your linear strip with a “hot” color that will attract attention in your space. We can powder coat to any finish with an economical adder



Orange (OR)



Red (RD)



Matte White (WH)



Black (BK)

LED CONTOURED STRIP

Wall or Ceiling mount, surface or pendant mounted, vertical or horizontal this fixture available standard in 3 sizes can be used individually or joined together for a continuous run. Standard in white but with a variety of finish options. Eight foot has one piece lens for a great look. See page 27 for continuous run wiring harness.



ITEM NO.	DESCRIPTION
USESEFR24LR14W1400LDMV40KWH	3.79"W x 23.60"L x 3.93"H / 14W, 1400L, 4000K
USESEFR24LR20W2000LDMV40KWH	3.79"W x 23.60"L x 3.93"H / 20W, 2000L, 4000K
USESEFR48LR28W2800LDMV40KWH	3.79"W x 47.20"L x 3.93"H / 28W, 2800L, 4000K
USESEFR48LR40W4000LDMV40KWH	3.79"W x 47.20"L x 3.93"H / 40W, 4000L, 4000K
USESEFR96LR56W5600LDMV40KWH	3.79"W x 94.40"L x 3.93"H / 56W, 5600L, 4000K
USESEFR96LR80W8000LDMV40KWH	3.79"W x 94.40"L x 3.93"H / 80W, 8000L, 4000K

with SENSOR

USESSERFR24LR14W1400LDMV40KWH	3.79"W x 23.60"L x 3.93"H / 14W, 1400L, 4000K
USESSERFR24LR20W2000LDMV40KWH	3.79"W x 23.60"L x 3.93"H / 20W, 2000L, 4000K
USESSERFR48LR28W2800LDMV40KWH	3.79"W x 47.20"L x 3.93"H / 28W, 2800L, 4000K
USESSERFR48LR40W4000LDMV40KWH	3.79"W x 47.20"L x 3.93"H / 40W, 4000L, 4000K
USESSERFR96LR56W5600LDMV40KWH	3.79"W x 94.40"L x 3.93"H / 56W, 5600L, 4000K
USESSERFR96LR80W8000LDMV40KWH	3.79"W x 94.40"L x 3.93"H / 80W, 8000L, 4000K

For Emergency, add EM

US Energy Services, Inc.

Ph: 512.407.8858 • Email Info Requests and Orders to: Sales@us-energyservices.com
www.us-energyservices.com

STRIPS

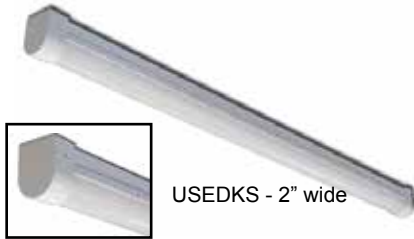

USEDKS - 2" wide

USEDKSWB - 3" wide

New Designer White Ends ideal for variety of applications.

LINEAR ROUND STRIP (IDEAL FOR VANITY LIGHTING)

ITEM NO.	DESCRIPTION
USEDKSMW24LH18W1750LDMV40KWH	2 ft x 2" / 18W, 1750L / Color Temp - 30, 35, 40, 50
USEDKSMW48LH35W3400LDMV40KWH	4 ft x 2" / 35W, 3400L / Color Temp - 30, 35, 40, 50
USEDKSWBMW48LE40W4000LDMV40KWH	4 ft x 3" / 40W, 4000L / Color Temp - 30, 35, 40, 50
USEDKSWBMW96LE80W8000LDMV40KWH	8 ft x 3" / 80W, 8000L / Color Temp - 30, 35, 40, 50

For emergency, add EM (Available in BN, BK or BZ and consult for adder. Consult for other wattages & lumens.



Consult for other finishes and adder.

LOW PROFILE LINEAR STRIP

ITEM NO.	SIZE (W X L)	Watts / Lumens	Color Options (X100 Kelvins)
USESKDFR24LE12W1200LDMV40KWH	2" x 22.5"	12 / 1200	30, 35, 40, 50
USESKDFR48LE28W2700LDMV40KWH	2" x 46"	28 / 2700	30, 35, 40, 50
USESKDFR48LH35W3400LDMV40KWH	2" x 46"	35 / 3400	30, 35, 40, 50
USESKDFR96LE57W5400LDMV40KWH	2" x 92"	57 / 5400	30, 35, 40, 50
USESKDFR96LH72W7000LDMV40KWH	2" x 92"	72 / 7000	30, 35, 40, 50

Only available with remote EM.

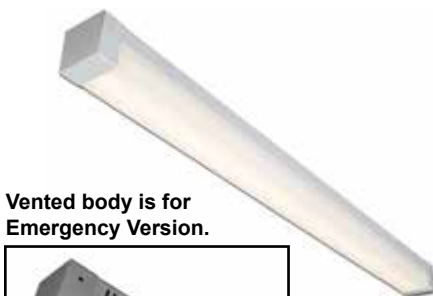

Vented body is for Emergency Version.



WIDE BODY LINEAR STRIP (3 INCH WIDE X 3 INCH HEIGHT)

ITEM NO.	DESCRIPTION
USESKDWBFR24LH35W3400LDMV40KWH	2 ft / 35W, 3400L / Color Temp 30, 35, 40, 50
USESKDWBFR48LE40W4000LDMV40KWH	4 ft / 40W, 4000L / Color Temp 30, 35, 40, 50
USESKDWBFR48LH72W7000LDMV40KWH	4 ft / 72W, 7000L / Color Temp 30, 35, 40, 50
USESKDWBFR96LH80W8000LDMV40KWH	8 ft / 80W, 8000L / Color Temp 30, 35, 40, 50
USESKDWBFR96LE114W10800LDMV40KWH	8 ft / 114W, 10800L / Color Temp 30, 35, 40, 50

For Brushed Nickel, Change WH to BN. For Bronze, Change WH to BZ. For Emergency, add EM. For Sensor Option add "SD" in front.

LED PREMIUM STRIP (IDEAL FOR CONTINUOUS RUNS)

ITEM NO.	DESCRIPTION
USECRSR48LT30W3500LDMV40K*	4.36"W x 48"L x 3.90"H/ ROUND LENS/ 30W, 3500L, 4000K
USECRSR48LT41W4300LDMV40K*	4.36"W x 48"L x 3.90"H/ ROUND LENS/ 41W, 4300L, 4000K
USECRSR48LT58W6700LDMV40K*	4.36"W x 48"L x 3.90"H/ ROUND LENS/ 58W, 6700L, 4000K
USECRSR96LT60W6900LDMV40K*	4.36"W x 96"L x 3.90"H/ ROUND LENS/ 60W, 6900L, 4000K
USECRSR96LT82W8900LDMV40K*	4.36"W x 96"L x 3.90"H/ ROUND LENS/ 82W, 8900L, 4000K
USECRSR96LT116W13400LDMV40K*	4.36"W x 96"L x 3.90"H/ ROUND LENS/ 116W, 13400L, 4000K
USECRSF48LT30W3500LDMV40K	4.36"W x 48"L x 3.90"H/ FLAT LENS/ 30W, 3500L, 4000K
USECRSF48LT41W4300LDMV40K	4.36"W x 48"L x 3.90"H/ FLAT LENS/ 41W, 4300L, 4000K
USECRSF48LT58W6700LDMV40K	4.36"W x 48"L x 3.90"H/ FLAT LENS/ 58W, 6700L, 4000K
USECRSF96LT60W6900LDMV40K	4.36"W x 96"L x 3.90"H/ FLAT LENS/ 60W, 6900L, 4000K
USECRSF96LT82W8900LDMV40K	4.36"W x 96"L x 3.90"H/ FLAT LENS/ 82W, 8900L, 4000K
USECRSF96LT116W13400LDMV40K	4.36"W x 96"L x 3.90"H/ FLAT LENS/ 116W, 13400L, 4000K



Fully luminous lens from end to end.



For Emergency, add EM

STRIPS



LINEAR FIXTURE

ITEM NO.	DESCRIPTION
USESEFR48LS31W3100LDMV40KWH	2.36"W x 47.25"L x 2.83"H / 31W, 3100L, 4000K
USESEFR48LR40W4000LDMV40KWH	2.36"W x 47.25"L x 2.83"H / 40W, 4000L, 4000K
USESEFR96LS62W6200LDMV40KWH	2.36"W x 94.43"L x 2.83"H / 62W, 6200L, 4000K
USESEFR96LR80W8000LDMV40KWH	2.36"W x 94.43"L x 2.83"H / 80W, 8000L, 4000K

Pendant mount available. Available in 3000K, 3500K, and 5000K. For Side Mount version with downlight change SES to SESW.

LED LENSED STRIP (4.25" WIDE)

ITEM NO.	DESCRIPTION
USEC24LFRF24W3000LDMV40K	4.25" x 24" / 24W, 3000L, 4000K
USEC24LFRF30W3400LDMV40K	4.25" x 24" / 30W, 3400L, 4000K
USEC48LFRF35W4500LDMV40K	4.25" x 48" / 35W, 4500L, 4000K
USEC48LFRF48W6000LDMV40K	4.25" x 48" / 48W, 6000L, 4000K
USEC48LFRF57W7100LDMV40K	4.25" x 48" / 57W, 7100L, 4000K
USEC96LFRF70W9100LDMV40K	4.25" x 96" / 70W, 9100L, 4000K
USEC96LFRF97W11900LDMV40K	4.25" x 96" / 97W, 11900L, 4000K
USEC96LFRF118W14200LDMV40K	4.25" x 96" / 118W, 14200L, 4000K

For Wire Guard add WG For Emergency, add EM

LED OPEN STRIP (4.25" WIDE) (CONSULT TO ADD REFLECTORS)

ITEM NO.	DESCRIPTION
USEC24LF24W3350LDMV40K*	4.25" x 24" / 24W, 3350L, 4000K
USEC24LF30W3900LDMV40K*	4.25" x 24" / 30W, 3900L, 4000K
USEC48LF35W4900LDMV40K*	4.25" x 48" / 35W, 4900L, 4000K
USEC48LF48W6500LDMV40K*	4.25" x 48" / 48W, 6500L, 4000K
USEC48LF57W7800LDMV40K*	4.25" x 48" / 57W, 7800L, 4000K
USEC96LF70W9800LDMV40K*	4.25" x 96" / 70W, 9800L, 4000K
USEC96LF97W13000LDMV40K*	4.25" x 96" / 97W, 13000L, 4000K
USEC96LF118W15500LDMV40K*	4.25" x 96" / 118W, 15500L, 4000K

LED OPEN STRIP (2.75" WIDE)

USES24LS12W1400LDMV40K	2.75" x 1.80" x 24.00" / 12W, 1400L, 4000K
USES48LS24W2800LDMV40K	2.75" x 1.80" x 48.00" / 24W, 2800L, 4000K
USES48LS28W3200LDMV40K	2.75" x 1.80" x 48.00" / 28W, 3200L, 4000K
USES48LH35W3400LDMV40K	2.75" x 1.80" x 48.00" / 35W, 3400L, 4000K
USES96LS57W6400LDMV40K	2.75" x 1.80" x 96.00" / 57W, 6400L, 4000K
USES96LH72W8200LDMV40K	2.75" x 1.80" x 96.00" / 72W, 8200L, 4000K

LED OPEN STRIP (1.62" WIDE) IDEAL FOR COVES

USEKDS48LS24W2800LDMV40K	1.62" x 1.62" x 48.00" / 24W, 2800L, 4000K
USEKDS48LS28W3200LDMV40K	1.62" x 1.62" x 48.00" / 28W, 3200L, 4000K
USEKDS48LH35W4000LDMV40K	1.62" x 1.62" x 48.00" / 35W, 4000L, 4000K
USEKDS96LS48W5650LDMV40K	1.62" x 1.62" x 96.00" / 48W, 5650L, 4000K
USEKDS96LS57W6400LDMV40K	1.62" x 1.62" x 96.00" / 57W, 6400L, 4000K
USEKDS96LH72W7000LDMV40K	1.62" x 1.62" x 96.00" / 72W, 7000L, 4000K

Available in 3000K, 3500K and 5000K. Add Wiring Harness for Continuous Runs - See Page 27. For Emergency, add EM



Lens End Cap
accessory.
CENDCAPLENS

Frosted lens
accessory reduces
LED brightness.
USEC48FRLN



Frosted lens
accessory reduces
LED brightness.
USES48FRLN



US Energy Services, Inc.

Ph: 512.407.8858 • Email Info Requests and Orders to: Sales@us-energyservices.com
www.us-energyservices.com

SMART STRIPS



MOUNTING

LINEAR FIXTURE w/ SENSOR

(FIXTURE ON WHEN OCCUPIED, OFF WHEN NOT)

ITEM NO.	DESCRIPTION
USESSSESFR24LH20W2000LDMV40KWH	2.36"W x 23.6"L x 2.83"H / 20W, 2000L, 4000K
USESSSESFR48LS31W3100LDMV40KWH	2.36"W x 47.25"L x 2.83"H / 31W, 3200L, 4000K
USESSSESFR96LS62W6200LDMV40KWH	2.36"W x 94.43"L x 2.83"H / 62W, 6200L, 4000K
USESSSESFR24LH20W2000LSTMV40KWH	2.36" x 23.6", 20W 2000L with 50% Step Dim
USESSSESFR48LS31W3100LSTMV40KWH	2.36" x 47.3", 31W 3100L with 50% Step Dim
USESSSESFR96LS62W6200LSTMV40KWH	2.36" x 94.43", 62W 6200L with 50% Step Dim

Step Dim w/Sensor (Fixture ON when occupied, 50% when not). Consult for other finishes. Pendant mount available. Available in 3000K, 3500K, and 5000K. Other Sensor Options See Page 4.



LED LINEAR w/DAYLIGHT HARVESTING SENSOR

ITEM NO.	DESCRIPTION
USESDSESFR24LH20W2000LDMV40KWH	2.36" x 23.6", 20W 2000L, Daylight Harvesting
USESDSESFR48LS31W3100LDMV40KWH	2.36" x 47.3", 31W 3100L, Daylight Harvesting
USESDSESFR96LS62W6200LDMV40KWH	2.36" x 94.43", 62W 6200L, Daylight Harvesting

SD - Daylight Harvesting Sensor in conjunction with 0-10V driver allow light level to adjust to ambient light. Available in 3000K, 3500K, and 5000K.



WIDE BODY LINEAR STRIP w/SENSOR

(FIXTURE ON WHEN OCCUPIED, OFF WHEN NOT)

ITEM NO.	DESCRIPTION
USESSSKDWBFR24LH35W3400LDMV40KWH	2 ft / 35W, 3400L / Color Temp 30, 35, 40, 50
USESSSKDWBFR48LE40W4000LDMV40KWH	4 ft / 40W, 4000L / Color Temp 30, 35, 40, 50
USESSSKDWBFR48LH72W7000LDMV40KWH	4 ft / 72W, 7000L / Color Temp 30, 35, 40, 50
USESSSKDWBFR96LH80W8000LDMV40KWH	8 ft / 80W, 8000L / Color Temp 30, 35, 40, 50
USESSSKDWBFR96LE114W10800LDMV40KWH	8 ft / 114W, 10800L / Color Temp 30, 35, 40, 50



LINEAR FIXTURE w/MICROWAVE SENSOR

ITEM NO.	DESCRIPTION
USESMFSFFR48LF31W3100LDMV40KWH	2.36"W x 47.25"L x 2.83"H / 31W, 3200L, 4000K
USESMFSFFR96LF62W6200LDMV40KWH	2.36"W x 94.43"L x 2.83"H / 62W, 6200L, 4000K

For Emergency, add EM NOTE: Center shadow for microwave sensor.

Dimming to 1%

Standard DMV provides dimming to 10% intensity.
For Dim to 1% up to 57watt, change DMV to D1MV

LINEAR PENDANT

Largest Selection of Linear LED Pendants
from Less than 1 inch Wide to 8 inch Wide at
Value Pricing.



Choose Your Finish



For continuous runs, see
ordering on page 26.



LINEAR 2" X 3" PENDANT (UPLIGHT OR DOWNLIGHT ONLY)

ITEM NO.	SIZE (W X L)	Watts / Lumens	Color Options (X100 Kelvins)
USE23PSF48LR26W2600LDMV40KWH-HC301WH	2" x 48"	26 / 2600	30, 35, 40, 50
USE23PSF48LR38W3800LDMV40KWH-HC301WH	2" x 48"	38 / 3800	30, 35, 40, 50
USE23PSF48LR45W4500LDMV40KWH-HC301WH	2" x 48"	45 / 4500	30, 35, 40, 50
USE23PSF96LR52W5200LDMV40KWH-HC301WH	2" x 96"	52 / 5200	30, 35, 40, 50
USE23PSF96LR76W7600LDMV40KWH-HC301WH	2" x 96"	76 / 7600	30, 35, 40, 50
USE23PSF96LR90W9000LDMV40KWH-HC301WH	2" x 96"	90 / 9000	30, 35, 40, 50

For Dimming, change "HC301WH" to "HC3015WWH"
For Surface Mounted, remove "HC301WH"
For Emergency(External Battery Backup), add EM and \$311.
For Up Light, Add "U" after "L".
For Dim to 1% up to 57watt, change DMV to D1MV

LINEAR 2" X 3" PENDANT (UPLIGHT AND DOWNLIGHT)

ITEM NO.	SIZE (W X L)	Watts Up/Down	Color Options (X100 Kelvins)
USE23PSF48LUR12WD24WDMV40KWH-HC301WH	2" x 48"	12 / 24	30, 35, 40, 50
USE23PSF48LUR18WD36WDMV40KWH-HC301WH	2" x 48"	18 / 36	30, 35, 40, 50
USE23PSF96LUR24WD48WDMV40KWH-HC301WH	2" x 96"	24 / 48	30, 35, 40, 50
USE23PSF96LUR36WD72WDMV40KWH-HC301WH	2" x 96"	36 / 72	30, 35, 40, 50

For Dimming, change "HC301WH" to "HC3015WWH"
For Surface Mounted, remove "HC301WH"
For Emergency(External Battery Backup),
For Dim to 1% up to 57watt, change DMV to D1MV

LINEAR 2.5" X 3.5" PENDANT (DOWNLIGHT ONLY)

ITEM NO.	SIZE (W X L)	Watts / Lumens	Color Options (X100 Kelvins)
USESES25PSF48LR26W2600LDMV40KWH-HC301WH	2.5" x 48"	26 / 2600	30, 35, 40, 50
USESES25PSF48LR38W3800LDMV40KWH-HC301WH	2.5" x 48"	38 / 3800	30, 35, 40, 50
USESES25PSF48LR45W4500LDMV40KWH-HC301WH	2.5" x 48"	45 / 4500	30, 35, 40, 50
USESES25PSF96LR52W5200LDMV40KWH-HC301WH	2.5" x 96"	52 / 5200	30, 35, 40, 50
USESES25PSF96LR76W7600LDMV40KWH-HC301WH	2.5" x 96"	76 / 7600	30, 35, 40, 50
USESES25PSF96LR90W9000LDMV40KWH-HC301WH	2.5" x 96"	90 / 9000	30, 35, 40, 50

For Dimming, change "HC301WH" to "HC3015WWH"
For Surface Mounted, remove "HC301WH"
For Emergency(External Battery Backup)



US Energy Services, Inc.

Ph: 512.407.8858 • Email Info Requests and Orders to: Sales@us-energyservices.com
www.us-energyservices.com

LINEAR PENDANT

LINEAR 4" X 4" PENDANT (DOWNLIGHT ONLY)



For continuous runs, see ordering on page 26.

ITEM NO.	SIZE (W X L)	Watts / Lumens	Color Options (X100 Kelvins)
USE44PSF48LR24W2400LDMV40KWH-HC301WH	4" x 48"	24 / 2400	30, 35, 40, 50
USE44PSF48LR48W4800LDMV40KWH-HC301WH	4" x 48"	48 / 4800	30, 35, 40, 50
USES4PSF96LR48W4800LDMV40KWH-HC301WH	4" x 96"	48 / 4800	30, 35, 40, 50
USE44PSF96LR96W9600LDMV40KWH-HC301WH	4" x 96"	96 / 9600	30, 35, 40, 50

For surface mount remove HC301WH and deduct. For emergency, add EM. For Dimming add "5W" after HC301. For Dim to 1% up to 57watt, change DMV to D1MV
For Indirect only options add U after the length and L.

Ex: USE44PSF48LR26W - becomes USE44PSF48LUR26W

SENSOR READY LINEAR 4" X 4" (DOWNLIGHT ONLY)



Consult for 2ft and custom sizes.

ITEM NO.	SIZE (W X L)	Watts / Lumens	Color Options (X100 Kelvins)
USESS44PSF48LR24W2400LDMV40KWH-HC301WH	4" x 48"	24 / 2400	30, 35, 40, 50
USESS44PSF48LR48W4800LDMV40KWH-HC301WH	4" x 48"	48 / 4800	30, 35, 40, 50
USESS44PSF96LR48W4800LDMV40KWH-HC301WH	4" x 96"	48 / 4800	30, 35, 40, 50
USESS44PSF96LR96W9600LDMV40KWH-HC301WH	4" x 96"	96 / 9600	30, 35, 40, 50

SS comes standard with Occupancy Sensor. For Daylight Harvesting change USESS to USESD

LINEAR 4" X 5" (UPLIGHT AND DOWNLIGHT)



For continuous runs, see ordering on page 26.

ITEM NO.	SIZE (W X L)	Watts Up / Down	Color Options (X100 Kelvins)
USE45PSF48LUR12WD24WDMV40KWH-HC301WH	4" x 48"	12 / 24	30, 35, 40, 50
USE45PSF48LUR18WD36WDMV40KWH-HC301WH	4" x 48"	18 / 36	30, 35, 40, 50
USE45PSF96LUR24WD48WDMV40KWH-HC301WH	4" x 96"	24 / 48	30, 35, 40, 50
USE45PSF96LUR36WD72WDMV40KWH-HC301WH	4" x 96"	36 / 72	30, 35, 40, 50

For surface mount remove HC301WH. For Emergency, add EM. For Dimming add "5W" after HC301. For Dim to 1% up to 57watt, change DMV to D1MV

LINEAR 6" X 6" PENDANT (UPLIGHT OR DOWNLIGHT ONLY)



For matching wall version, see page 41.

ITEM NO.	DESCRIPTION
USE66PSF48LR24W2400LDMV40KWHHC401WH	6.00" X 6.00" X 48" / 24W, 2400L, 4000K
USE66PSF48LR48W4800LDMV40KWHHC401WH	6.00" X 6.00" X 48" / 48W, 4800L, 4000K
USE66PSF96LR48W4800LDMV40KWHHC401WH	6.00" X 6.00" X 96" / 48W, 4800L, 4000K
USE66PSF96LR97W9600LDMV40KWHHC401WH	6.00" X 6.00" X 96" / 97W, 9600L, 4000K

For Emergency, add EM. For Dimming add "5W" after HC301WH

Now Available with Snap Fit lens specially designed for LED Arrays. Change MW to SF for Snap Fit Lens. For Up Light, Add "U" after "L". For Dim to 1% up to 57watt, change DMV to D1MV

LINEAR 6" X 6" PENDANT (UPLIGHT AND DOWNLIGHT)

ITEM NO.	DESCRIPTION	Watts Up / Down	Color Options (X100 Kelvins)
USE66PSF48LUR12WD24WDMV40KWHHC401WH	6.00" X 6.00" X 48"	12 / 24	30, 35, 40, 50
USE66PSF48LUR24WD48WDMV40KWHHC401WH	6.00" X 6.00" X 48"	24 / 48	30, 35, 40, 50
USE66PSF96LUR24WD48WDMV40KWHHC401WH	6.00" X 6.00" X 96"	24 / 48	30, 35, 40, 50
USE66PSF96LUR36WD72WDMV40KWHHC401WH	6.00" X 6.00" X 96"	36 / 72	30, 35, 40, 50

Wall washer option

Now Available with Snap Fit lens specially designed for LED Arrays. Change SF to MW for Matte White Lens. For Dim to 1% up to 57watt, change DMV to D1MV

US Energy Services, Inc.

LINEAR PENDANT



Linear configurations with lit or unlit corner options provide a dramatic look and lighting effect that completely change the aesthetics of the space. If you can dream it, we can make it.



Lit corners

Consult for Different Configurations
(Squares or Rectangles, Up and Downlight Versions, or Different Shapes of Lit Patterns)

4X4 SQUARE IN 4FT SQ AND 8FT SQ (DOWNLIGHT) 6 OR 8 WATTS PER FOOT

ITEM NO.	DESCRIPTION
USE44PSF4X4R96WDMV40KWHHC401WH	4x4" 4ft. Sq / 96W, 9600L / White 3 Wire Cord
USE44PSF4X4R96WDMV40KWHHC4015WWH	4x4" 4ft. Sq / 96W, 9600L / White 5 Wire Cord for 0-10V Dim
USE44PSF4X4R128WDMV40KWHHC401WH	4x4" 4ft. Sq / 128W, 12800L / White 3 Wire Cord
USE44PSF4X4R128WDMV40KWHHC4015WWH	4x4" 4ft. Sq / 128W, 12800L / White 5 Wire Cord for 0-10V Dim
USE44PSF8X8R192WDMV40KWHHC401WH	4x4" 8ft. Sq / 192W, 19200L / White 3 Wire Cord
USE44PSF8X8R192WDMV40KWHHC4015WH	4x4" 8ft. Sq / 192W, 19200L / White 5 Wire Cord for 0-10V Dim
USE44PSF8X8R256WDMV40KWHHC401WH	4x4" 8ft. Sq / 256W, 25600L / White 3 Wire Cord
USE44PSF8X8R256WDMV40KWHHC4015WWH	4x4" 8ft. Sq / 256W, 25600L / White 5 Wire Cord for 0-10V Dim

For Emergency, add EM. Consult for up and downlight. Available in 3000k, 3500K and 5000K. For Dim to 1% up to 57watt, change DMV to D1MV

LINEAR 4"X 4" PENDANT (DOWNLIGHT ONLY) UNLIT CORNERS



For continuous runs, see ordering on page 26.



Joiner Box

ITEM NO.	SIZE (W X L)	Watts / Lumens	Color Options (X100 Kelvins)
USE44PSF48LR24W2400LDMVPI3D40KWH-HC301WH	4" x 48"	24 / 2400	30, 35, 40, 50
USE44PSF48LR48W4800LDMVPI3D40KWH-HC301WH	4" x 48"	48 / 4800	30, 35, 40, 50
USE44PSF96LR48W4800LDMVPI3D40KWH-HC301WH	4" x 96"	48 / 4800	30, 35, 40, 50
USE44PSF96LR96W9600LDMVPI3D40KWH-HC301WH	4" x 96"	96 / 9600	30, 35, 40, 50
USE44JB1WAYWH	Straight Joiner		
USE44JB2WAYWH	90 Degree Joiner		
USE44JB3WAYWH	T Connector (3 Way)		
USE44JB4WAYWH	X Connector (4 Way)		
USE44E10WAYWH	End of Run		

For surface mount remove HC301WH For emergency, add EM. For Dimming add "5W" after HC301 For Dim to 1% up to 57watt, change DMV to D1MV
PATTERNS W/NON LIT CORNERS - Choose Straight Run USE44 Series Pendants and Then Choose Appropriate Non Lit Corner Accessory (Consult Light for 45 Series Up and Down Option or other Sizes)

US Energy Services, Inc.

Ph: 512.407.8858 • Email Info Requests and Orders to: Sales@us-energyservices.com
www.us-energyservices.com

LINEAR PENDANT



Shown custom finish.

4" X 4" LINEAR X SERIES

ITEM NO.	DESCRIPTION
USEX44PSF2X2R48WDMV40KWHHC4015WWH	4" X 4" 2 FT CROSS DIMMABLE, 48W Total and 12W Per 2ft Run, 4800 Lumens, White 5 Wire Cord for 0-10V Dim
USEX44PSF4X4R96WDMV40KWHHC4015WWH	4" X 4" 4 FT CROSS DIMMABLE, 96W Total and 24W Per 4ft Run, 9600 Lumens, White 5 Wire Cord for 0-10V Dim

Consult for Different shapes, sizes or finishes.

You can draw it, we can make it!

Ordering Patterns

US Energy Services can create patterns with 23, 44, 45 and 66 Series. Patterns are available for recessed and pendant mounting versions with lit corners or unlit corners. See below for some of the possibilities and consult factories for exact ordering numbers and pricing.



Continuous Run Ordering for USE23, USE44, USE45, USE66, USELPLIN and USESLP Series

1. Determine the run length and whether the run will be dimmed or not.
2. Use the above 2, 4 or 8 ft. runs from the Series Specified to add up to total run length. Use the largest individual fixtures to achieve run lengths (i.e. for 20 ft. run use 2x8 ft. individuals and 1x4 ft. individual from above with the correct ordering info for your series). Watts and lumens for each section should be proportional for the size (i.e. If 48W with 4 ft then 8 ft should be 96W). Consult for other lengths.
3. Designate each length required in the run whether it will be the beginning of the run "B", joiner in the run "J" or the end "E" of the run. **Add the letter designation to the end of the part number.**
4. For Plug and Play electrical wiring between individual fixtures in the run, add one of the following harnesses. The number of wires is based on whether the run will be dimmable, with emergency or just ON/OFF.

Add Wiring Harness Code After the Driver Designation

- PI1 - 3 Wire Harness (normally for non-dim applications)
- PI2 - 4 Wire Harness (normally for emergency circuit)
- PI3D - 5 Wire Harness (normally for 0-10V dimming)
- PI4D - 6 Wire Harness (normally for 0-10V dimming and emergency)



Engineered ends either accept end cap to complete run or to join two fixtures together for continuous runs

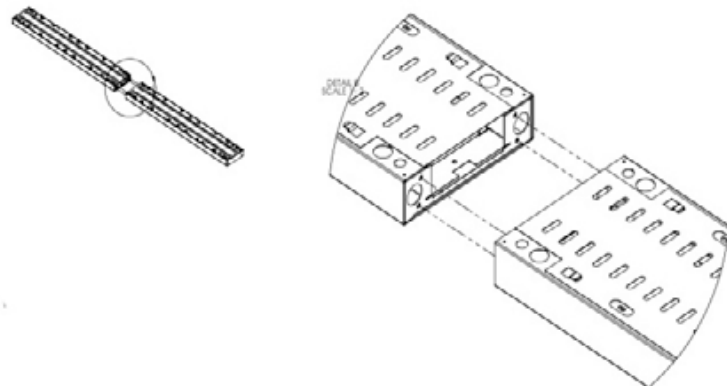

For continuous runs, first remove the end plates on the fixtures you want to join together; then using bolts and nuts (4X), attach the two ends together. Be sure both fixtures are properly aligned before tightening the bolts. Repeat steps for as long as you would like to continuous run the fixtures. Finish run with the end plate attached to the last fixture in the run

US Energy Services, Inc.

Ph: 512.407.8858 • Email Info Requests and Orders to: Sales@us-energyservices.com
www.us-energyservices.com

LINEAR PENDANT

All-In-One LED Channels Most Popular Pre-Configured Kits



****Individual or Continuous Use****

****Convenient and Simple to Install****

Based on your feedback, our brand new All-In-One LED Linear Channel is new and improved to provide the easiest channel in the industry to specify, order, and install. This integral driver channel in two different profiles provides the ideal solution for both individual fixtures (in 4 or 8 foot), and to join multiple channels for longer, continuous runs (in 4 or 8 foot multiples). This beautifully finished aluminum channel is so easy to install that the "do-it-yourselfer" can install in minutes; and professional installers will appreciate not only the reduction in cost, but also the speed in which installation can be completed. A specially designed integral wiring harness (ordered separately) makes joining two channels electronically simple and efficient. A unique, mechanical joiner bracket in conjunction with our special joiner tool allows for joining two or more channels together with no light leak and a clean connection.

2 Sizes Ready to Ship!

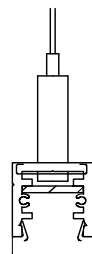

USELLSF*
2.16" Wide, 2.75" Tall

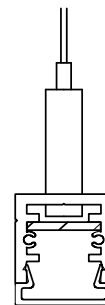

USELLSG*
3.54" Wide, 3.38" Tall

* Available for Pendant Mounting & Surface Mounting applications

Custom Finishes Available

US Energy Services, Inc.

Ph: 512.407.8858 • Email Info Requests and Orders to: Sales@us-energyservices.com
www.us-energyservices.com

LINEAR PENDANT

Order one item number for complete luminaires!

From 4 Ft to 16 Ft
and Beyond.

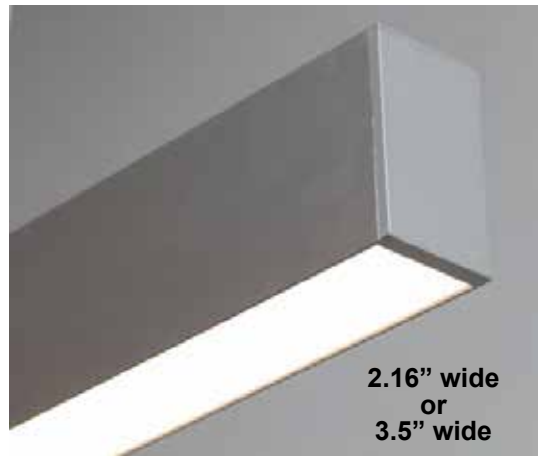

FEATURES INCLUDE:

- Aluminum Channel
- Integral Driver
- Snap Fit Lens
- Magnetic Light Leak Block
- Integral Wire Harness

Joins easily with a mechanical spline



*Three-part system
allows for easy wiring
with prewired harnesses
and allows for custom
finishes on channel
(Consult)*

Nomenclature shown reflects 3000K Color Temperature. Change "30K" to "40K" for 4000K Color Temperature

***All hanging kits come with a White Canopy. Standard hanging kit length is 72".*

For 144" hanging kit, please replace "HC605WH" with "HC612WH" (W-DMV-30K-SA-HC612WH).

USELLSG **USELLSF**
3.5"x3.3H 2.2"Wx2.8"H



USELLSFLENSTOOL

Tool Required to Remove Lens and
Tool Required to Remove Harness
(1 per Installation needed)



USELLSGJOINERTOOL

Tool Required to Use Mechanical
Joiner (1 per Installation of
Continuous Runs)

US Energy Services, Inc.

Ph: 512.407.8858 • Email Info Requests and Orders to: Sales@us-energyservices.com
www.us-energyservices.com

LINEAR PENDANT

LED LINEAR CHANNEL IN 2 SIZES w/ INTEGRAL DRIVER

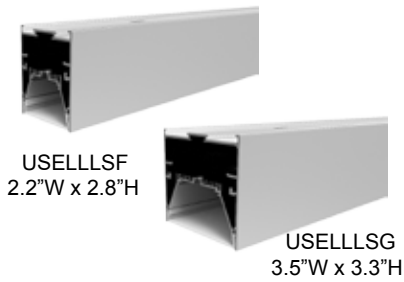

USELLLSF
2.2\"/>

USELLLSG
3.5\"/>

ITEM NO.	DESCRIPTION
USELLLSF - Alum. Channel 2.2\"/> 	
USELLLSF48L30W3000LDMV40KSA	30W 3000L, 4000K 0-10V Dimming Multi-Volt
USELLLSF96L60W6000LDMV40KSA	60W 6000L, 4000K 0-10V Dimming Multi-Volt
USELLLSG - Alum. Channel 3.5\"/> 	
USELLLSG48L48W5040LDMV40KSA	48W 5040L, 4000K 0-10V Dimming Multi-Volt
USELLLSG96L96W10080LDMV40KSA	96W 10080L, 4000K 0-10V Dimming Multi-Volt

Change 40K to 30K for 3000K

Consult for Finish Options.

JOIN TWO OR MORE CHANNELS TOGETHER

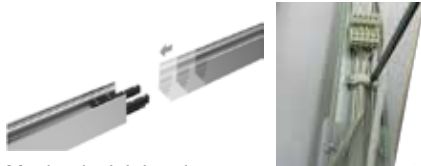

Mechanical Joiner is Simple and Clean and requires special tool.

Wiring Harness 5\"/>

ITEM NO.	DESCRIPTION
USELLLSFJOINER	Mechanical Joiner to Join 2 LLLSF Channels
USELLLSGJOINER	Mechanical Joiner to Join 2 LLLSG Channels
USELLLSGJOINERTOOL	Tool Required to Use Mechanical Joiner (1 per Installation)
USELLLSFLENSTOOL	Tool Required to Remove Lens; 1 per installation needed
USELLLSF5WMFH*	Wiring Harness 5\"/>

*Included with Channels only need to purchase for replacements

3 MOUNTING OPTIONS (SURFACE, PENDANT AND RECESSED)

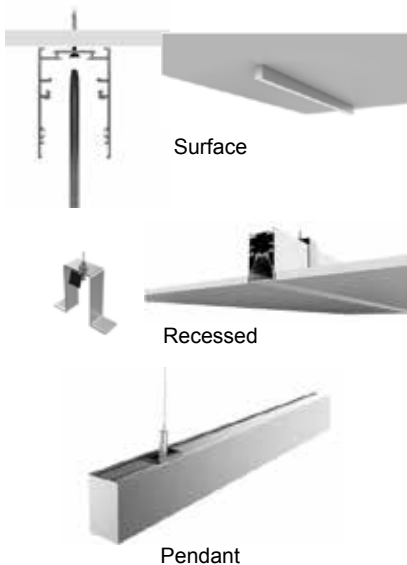

Surface

Recessed

Pendant

ITEM NO.	DESCRIPTION
USELLLSFSURFKIT	Surface Mount Screw and Toggle Set of 3 (Includes 24 inch power cord)
USELLLSFRECKIT*	Recessed Mounting Brackets for LLLSF (Set of 2) (Includes 24 inch power cord)
USELLLSGRECKIT*	Recessed Mounting Brackets for LLLSG (Set of 2) (Includes 24 inch power cord)
USELLLSFHCFPF605WWH**	Pendant Mounting Power Feed Canopy Kit 5 Wire for up to 6FT Drop
USELLLSFHCFPF6125WWH**	Pendant Mounting Power Feed Canopy Kit 5 Wire for up to 12FT Drop
USELLLSFHCFNPF605WWH	Pendant Mounting Non-Power Canopy Kit, 6 FT Cable with Canopy
USELLLSFHCFNPF612WWH	Pendant Mounting Non-Power Canopy Kit, 12 FT Cable with Canopy

* Aluminum Channel has no flange so review Recessed Application to ensure this will work.

**Use One Power Feed Canopy Kit every place mounting to Power. Non Power Feed Version Order Separately for Mounting where No Power Feed is Required.

LINEAR PENDANT

LED LINEAR PENDANT (1.57" Wide and 6 Watts Per FT)



1.57" Wide x 2.54" Height Satin Aluminum. Requires Remote Driver.

ITEM NO.	DESCRIPTION
USELLSH48L24W2125L30KSA	47.24" Square Pendant 1.57"W x 2.54"H SH Channel w/lens and 2 end caps and tape 30K installed with 10' clear wire
USELLSH48L24W2125L40KSA	47.24" Square Pendant 1.57"W x 2.54"H SH Channel w/lens and 2 end caps and tape 40K installed with 10' clear wire
USELLSH96L49W4335L30KSA	96.46" Square Pendant 1.57"W x 2.54"H SH Channel w/lens and 2 end caps and tape 30K installed with 10' clear wire
USELLSH96L49W4335L40KSA	96.46" Square Pendant 1.57"W x 2.54"H SH Channel w/lens and 2 end caps and tape 40K installed with 10' clear wire

Order driver and accessories separately.

Available in custom sizes and patterns. We make it easy!

USELLSH PATTERNS OPTIONS

ITEM NO.	DESCRIPTION
USELLSHCAP	END CAP
USELLSHLOCKER	Internal Locker for GEAR TRAY
USELLSHRECClip	RECESSED SCREW CLIP
USELLSHWALLCLIP	WALL MOUNT ELL CLIP
USELLSHJOINER	Joiner Spline for LLL SH Extrusion
USELLSHCORNER30K	90° FLAT CORNER 3000K
USELLSHCORNER40K	90° FLAT CORNER 4000K
USELLSHTEE30K	FLAT "T" 3000K
USELLSHTEE40K	FLAT "T" 4000K
USELLSHCROSS30K	FLAT X-CROSS 3000K
USELLSHCROSS40K	FLAT X-CROSS 4000K
USELLSHHC601WH	LLLSH Pendant parts kit 2M
USELLSHHC602WH	LLLSH Pendant parts kit 4M



End Cap



Internal Locker



Screw Clip



USELL Clip



Flat Corner



Flat "T"



X-Cross



Pendant Kit

REMOTE DRIVER (Dimmable with any standard MLV Triac (leading edge) control)



ITEM NO.	DESCRIPTION	Watts
USEMTIM60L24DC	Magnitude Magnetic Driver 60W 24VDC Encased	60
USEMTIM100L24DC	Magnitude Magnetic Driver 96W 24VDC Encased	96
USEMTIM150L24DC	Magnitude Magnetic Driver 150W 24VDC Encased	150

Consult for other drivers and wattages.

US Energy Services, Inc.

Ph: 512.407.8858 • Email Info Requests and Orders to: Sales@us-energyservices.com
www.us-energyservices.com

LINEAR PENDANT

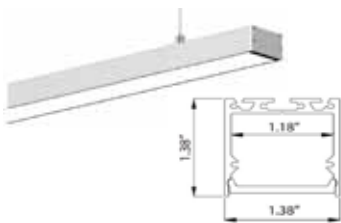
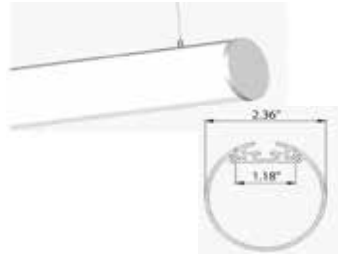

Consult for accessories to make patterns

LED Linear Channels w/ Remote Drivers (LLL Series)

USELLLRA 1.5" Diameter, 3 watts per ft

ITEM NO.	DESCRIPTION	WATTS
USELLLRA48L35W2246L30KSA	47.75" Round 1.6" Dia. RA Channel w/Lens and 2 End Caps and Tape 30K Installed with 10' Clear Wire	35
USELLLRA97L69W4492L30KSA	92" Round 1.6" Dia. RA Channel w/Lens and 2 End Caps and Tape 30K Installed with 10' Clear Wire	69

Not available for surface mount. See accessories below.

USELLLRB 2.4" Diameter, 4 watts per ft

USELLLRB47L42W2488L30KSA	47.75" Round 2.36" Dia. RB Extrusion w/Lens and 2 End Caps and Tape 30K Installed with 10' Clear Wire	42
USELLLRB99L96W4976L30KSA	96" Round 2.36" Dia. RB Extrusion w/Lens and 2 End Caps and Tape 30K Installed with 10' Clear Wire	83

See accessories below.

USELLLSA 0.78" Diameter, 2 watts per ft

USELLLSA48L23W1500L30KSA	47.75" Square 0.77" SA Channel w/Lens and 2 End Caps and Tape 30K Installed with 10' Clear Wire	23
USELLLSA97L46W3000L30KSA	97" Square 0.77" SA Channel w/Lens and 2 End Caps and Tape 30K Installed with 10' Clear Wire	46

See accessories below.

USELLLSB 1.4" Diameter, 4 watts per ft

USELLLSB47L42W2488L30KSA	47" Square 1.38" SB Channel w/Lens and 2 End Caps and Tape 30K Installed with 10' Clear Wire	42
USELLLSB96L83W4976L30KSA	96" Square 1.38" SB Channel w/Lens and 2 End Caps and Tape 30K Installed with 10' Clear Wire	83

See accessories below.

USELLLSC 1.9" Diameter, 5 watts per ft

USELLLSC48L58W3456L30KSA	47.75" Rect. 1.92W" x 2.75H" SC Extrusion w/Lens and 2 End Caps and Tape 30K Installed with 10' Clear Wire	58
USELLLSC97L115W6912L30KSA	97" Rect. 1.92W" x 2.75H" SC Extrusion w/Lens and 2 End Caps and Tape 30K Installed with 10' Clear Wire	115

See accessories below.

Consult for Custom Finish.

Drivers and Accessories

ITEM NO.	DESCRIPTION
USEMTIM40L24DC	Magniture Magnetic Driver 40W 24VDC Encased
USEMTIM60L24DC	Magniture Magnetic Driver 60W 24VDC Encased
USEMTIM100L24DC	Magniture Magnetic Driver 96W 24VDC Encased
USEMTIM150L24DC	Magniture Magnetic Driver 150W 24VDC Encased
Cable Kits	
USEHC601WH	Cable kit with 6' cable and power feed/cable incl. and white canopy
USEHC602WH	Cable kit with 12' cable and power feed/cable incl. and white canopy
Joiners	
USELLLRAJOIN	Mechanical joiner spline for RA and SC
USELLLSAJJOIN	Mechanical joiner spline for RB, SA and SB

Change 30K to 40K for 4000 color temperature. Consult for surface mount to order channel and tape separately.

US Energy Services, Inc.

Ph: 512.407.8858 • Email Info Requests and Orders to: Sales@us-energyservices.com
www.us-energyservices.com

LINEAR PENDANT

BULLNOSE STYLE WITH DIRECT/INDIRECT LIGHTING



For continuous runs, see ordering on page 27.

ITEM NO.	SIZE	Watts	Color Temp
USESLPLINFRSS48LUS12WD24WDMV40KWH-HC401WH	48"	12W Up 24W Down	30, 35, 40, 50
USESLPLINFRSS48LUS18WD36WDMV40KWH-HC401WH	48"	18W Up 36W Down	30, 35, 40, 50
USESLPLINFRSS96LUS24WD48WDMV40KWH-HC401WH	96"	24W Up 48W Down	30, 35, 40, 50
USESLPLINFRSS96LUS36WD72WDMV40KWH-HC401WH	96"	36W Up 72W Down	30, 35, 40, 50

For 0-10 Dimming. Change 401WH to 4015WWH. For Emergency, add EM.
Consult for other Direct/Indirect Options.

Ideal for Direct/Indirect Applications

LINEAR WINDOW LED WITH DIRECT/INDIRECT LIGHTING

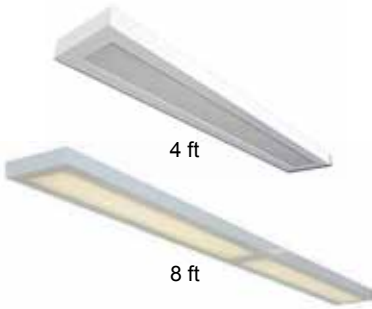

For continuous runs, see ordering on page 27.

For Wall version see page 43.

ITEM NO.	SIZE	Watts	Color Temp
Downlight			
USESLPFR48LS48W4800LDMV40KWH-HC401WH	7.6" x 48" 48W, 4800L, All downlight, Color Temp 30, 35, 40, 45		
USESLPFR96LS96W9600LDMV40KWH-HC401WH	7.6" x 96" 96W, 9600L, All downlight, Color Temp 30, 35, 40, 45		
Up and Downlight			
USESLPMW48LUS12WD24WDMV40KWH-HC401WH	48"	12W Up 24W Down	30, 35, 40, 50
USESLPMW48LUS18WD36WDMV40KWH-HC401WH	48"	18W Up 36W Down	30, 35, 40, 50
USESLPMW96LUS24WD48WDMV40KWH-HC401WH	96"	24W Up 48W Down	30, 35, 40, 50
USESLPMW96LUS36WD72WDMV40KWH-HC401WH	96"	36W Up 72W Down	30, 35, 40, 50

For 0-10 Dimming. Change 401WH to 4015WWH. For Emergency, add EM
Consult for other Direct/Indirect Options. Change WH to BN for Brushed Nickel
For LED arrays angled for partial up and downlight add UD after S.
Consult for smart sensor option.

Add this Emergency to most LED Fixtures with Array and Driver



The **ILB-CP10** from IOTA Engineering is a UL Classified LED emergency driver that allows the same LED fixture to be used for both normal and emergency operation. In the event of a power failure, the **ILB-CP10** switches to the emergency mode and operates the existing fixture for **90 minutes**. The unit contains a battery, charger, and converter circuit in a single can and is available in different mounting configurations for individual fixture requirements. The **ILB-CP10** will operate an LED array load at 10 watts with constant power at a rated output voltage of 10V-60V. The Constant Power design of the **ILB-CP10** maintains the output wattage even as the system voltage diminishes. Also suitable for field installation

LINEAR PENDANT



USELINMW
Matte White Lens



USELINLV
Louvered

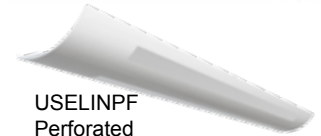

USELINPF
Perforated

LINEAR INDIRECT LIGHTING (NOT AVAILABLE FOR DOWNLIGHT ONLY)

ITEM NO.	SIZE	WATTS/LUMENS	Color Temp (X100 Kelvins)
USELINMW48LUS24WD12WDMV40KWH-HC301WH	48"	24W Up 12W Down	30, 35, 40, 50
USELINMW48LUS36WD18WDMV40KWH-HC301WH	48"	36W Up 18W Down	30, 35, 40, 50
USELINMW96LUS48WD24WDMV40KWH-HC301WH	96"	48W Up 24W Down	30, 35, 40, 50
USELINMW96LUS72WD36WDMV40KWH-HC301WH	96"	72W Up 36W Down	30, 35, 40, 50

For Emergency, add EM. For Dimming, change "HC301WH" to "HC3015WWH"
Consult for other Direct/Indirect Options. Change WH to BN for Brushed Nickel
For Louver, change MW to LV
For Perforated, change MW to PF

LED HIGH BAY BAFFLE (IDEAL FOR GENERAL MERCHANDISING)



ITEM NO.	DESCRIPTION
USEFHBL48LS32W4050LM20DMV40K	HI BAY BAFFLE 11.25"W x 48"L x 4.25"H - 4050lm - 4000K - 0-10V dimmable
USEFHBL48LS48W5650LM20DMV40K	HI BAY BAFFLE 11.25"W x 48"L x 4.25"H - 5650lm - 4000K - 0-10V dimmable
USEFHBL48LS57W6400LM20DMV40K	HI BAY BAFFLE 11.25"W x 48"L x 4.25"H - 6400lm - 4000K - 0-10V dimmable
USEFHBL48LH72W8200LM20DMV40K	HI BAY BAFFLE 11.25"W x 48"L x 4.25"H - 8200lm - 4000K - 0-10V dimmable
USEFHBL96LS97W11300LM20DMV40K	HI BAY BAFFLE 11.25"W x 96"L x 4.25"H - 11300lm - 4000K - 0-10V dimmable
USEFHBL96LS114W12800LM20DMV40K	HI BAY BAFFLE 11.25"W x 96"L x 4.25"H - 12800lm - 4000K - 0-10V dimmable

Consult for Inlay Lens. For Emergency, add EM. Available in 3000K, 3500K and 5000K.

For Continuous Runs, add Wire Harnessing, see page 27.

LED LINEAR STEPPED PENDANT w/LENS



New Door Frame and Lens is a high style option for LED.

Consult for finish options.

ITEM NO.	DESCRIPTION
USEFHBFR48LS32W4050LM20DMV40K	HI BAY BAFFLE 11.25"W x 48"L x 4.25"H - 4050lm - 4000K - 0-10V dimmable
USEFHBFR48LS48W5650LM20DMV40K	HI BAY BAFFLE 11.25"W x 48"L x 4.25"H - 5650lm - 4000K - 0-10V dimmable
USEFHBFR48LS57W6400LM20DMV40K	HI BAY BAFFLE 11.25"W x 48"L x 4.25"H - 6400lm - 4000K - 0-10V dimmable
USEFHBFR48LH72W8200LM20DMV40K	HI BAY BAFFLE 11.25"W x 48"L x 4.25"H - 8200lm - 4000K - 0-10V dimmable
USEFHBFR96LS97W11300LM20DMV40K	HI BAY BAFFLE 11.25"W x 96"L x 4.25"H - 11300lm - 4000K - 0-10V dimmable
USEFHBFR96LS114W12800LM20DMV40K	HI BAY BAFFLE 11.25"W x 96"L x 4.25"H - 12800lm - 4000K - 0-10V dimmable

For Emergency, add EM. Available in 3000K, 3500K and 5000K.

US Energy Services, Inc.

Ph: 512.407.8858 • Email Info Requests and Orders to: Sales@us-energyservices.com
www.us-energyservices.com

LINEAR PENDANT

LOUVERED 6" DECORATIVE LINEAR



ITEM NO.	DESCRIPTION
USELVS648LS48W5650LDMV40KWHHC301WH	6" Louvered Suspended 48"L 48Watt 5650 Lumens 5000K
USELVS648LS57W6400LDMV40KWHHC301WH	6" Louvered Suspended 48"L 57Watt 6400 Lumens 5000K
USELVS648LH72W8200LDMV40KWHHC301WH	6" Louvered Suspended 48"L 72Watt 8200 Lumens 5000K
USELVS696LS48W5650LDMV40KWHHC301WH	6" Louvered Suspended 96"L 48Watt 5650 Lumens 5000K
USELVS696LS96W11300LDMV40KWHHC301WH	6" Louvered Suspended 96"L 96Watt 11300 Lumens 5000K
USELVS696LS114W12800LDMV40KWHHC301WH	6" Louvered Suspended 96"L 114Watt 12800 Lumens 5000K
USELVS696LH144W16450LDMV40KWHHC301WH	6" Louvered Suspended 96"L 144Watt 16450 Lumens 5000K

For Inlay Lens add MW after USELVS6
 For Emergency, add EM. For Dimming, change "HC301WH" to "HC3015WWH"
 Available in Black (BK), Silver (SL), Bronze (BZ) or Galvanize (GV)

LOUVERED 8" DECORATIVE LINEAR



Shown in Black (BK).

ITEM NO.	DESCRIPTION
USELVS48LS48W5650LDMV40KWHHC301WH	8" Louvered Suspended 48"L 48Watt 5650 Lumens 5000K
USELVS48LS57W6400LDMV40KWHHC301WH	8" Louvered Suspended 48"L 57Watt 6400 Lumens 5000K
USELVS48LH72W8200LDMV40KWHHC301WH	8" Louvered Suspended 48"L 72Watt 8200 Lumens 5000K
USELVS96LS48W5650LDMV40KWHHC301WH	8" Louvered Suspended 96"L 48Watt 5650 Lumens 5000K
USELVS96LS97W11300LDMV40KWHHC301WH	8" Louvered Suspended 96"L 96Watt 11300 Lumens 5000K
USELVS96LS114W12800LDMV40KWHHC301WH	8" Louvered Suspended 96"L 114Watt 12800 Lumens 5000K
USELVS96LH144W16450LDMV40KWHHC301WH	8" Louvered Suspended 96"L 144Watt 16450 Lumens 5000K

Available in 3000K, 3500K and 5000K. For Inlay Lens add MW after USELVS
 For Emergency, add EM. For Dimming, change "HC301WH" to "HC3015WWH"
 Available in Black (BK), Silver (SL), Bronze (BZ) or Galvanize (GV)

MEDIUM BODY DECORATIVE STRIP



ITEM NO.	DESCRIPTION
USEDID48LS48W4800LW30BFDMV40K	Decorative Strip 48"L 48Watt 4800 Lumens 4000K
USEDID48LS57W5400LW30BFDMV40K	Decorative Strip 48"L 57Watt 5400 Lumens 4000K
USEDID48LH72W7000LW30BFDMV40K	Decorative Strip 48"L 72Watt 7000 Lumens 4000K
USEDID96LS96W9600LW30BFDMV40K	Decorative Strip 96"L 96Watt 9600 Lumens 4000K
USEDID96LS114W10800LW30BFDMV40K	Decorative Strip 96"L 114Watt 10800 Lumens 4000K
USEDID96LH144W14000LW30BFDMV40K	Decorative Strip 96"L 144Watt 14000 Lumens 4000K

Reflector Options: W30 - White Steel, P10 - Perforated, M24-Full Specular.
 Basket Options: BP - Perforated, BF - Fine Fluted lens, BL - Smooth White Lens.
 Consult factory for Brushed Nickel and other finishes.

US Energy Services, Inc.

Ph: 512.407.8858 • Email Info Requests and Orders to: Sales@us-energyservices.com
www.us-energyservices.com

SURFACE LINEAR LED

PREMIUM LOW PROFILE WELDED SURFACE FLAT PANEL

Most shroud kits for flat panels have unsightly seams in the corners. This welded body encloses Flat Panel without visual seams and requires no tools to install.



ITEM NO.	DESCRIPTION
USESHPFPELP22LED40DMVWH40	2x2 / 40W, 5000L, 4000K, 0-10V Dim, Color Temp - 35,40, 50
USESHPFPELP14LED40DMVWH40	1x4 / 40W, 5000L, 4000K, 0-10V Dim, Color Temp - 35,40, 50
USESHPFPELP24LED50DMVWH40	2x4 / 50W, 6250L, 4000K, 0-10V Dim, Color Temp - 35,40, 50

SURFACE SHROUD FOR FLAT PANELS

This specially designed shroud kit allows most flat panels to be surface mounted with a sleek, fresh appearance.



ITEM NO.	DESCRIPTION
USESHPFPELP22WH	2x2x3.5" Deep Surface Kit for Most 2x2 Flat Panels
USESHPFPELP14WH	1x4x3.5" Deep Surface Kit for Most 1x4 Flat Panels
USESHPFPELP24WH	2x4x3.5" Deep Surface Kit for Most 2x4 Flat Panels

For economy shroud see page 5. Order flat panels separately.

LED SURFACE TROFFER (WELDED SEAMLESS BODY)



ITEM NO.	SIZE (W X L)	Watts / Lumens	Color Options (X100 Kelvins)
USE153A22LF24W2400LDMV40K	2 x 2	24 / 2400	30, 35, 40, 50
USE153A22LF28W2700LDMV40K	2 x 2	28 / 2700	30, 35, 40, 50
USE153A22LF35W3200LDMV40K	2 x 2	35 / 3200	30, 35, 40, 50
USE153A14LF32W3450LDMV40K	1 x 4	32 / 3450	30, 35, 40, 50
USE153A14LF48W4800LDMV40K	1 x 4	48 / 4800	30, 35, 40, 50
USE153A24LF35W3650LDMV40K	2 x 4	35 / 3650	30, 35, 40, 50
USE153A24LF48W4800LDMV40K	2 x 4	48 / 4800	30, 35, 40, 50
USE153A24LF56W6050LDMV40K	2 x 4	56 / 6050	30, 35, 40, 50

For Emergency, add EM. Dress up with higher efficient Frosted Lens made special for LED. Replace "A" with "FR"

ENGINEERED WRAPAROUND WITH SOLID ENDS

Heavy duty construction ideal for individual or continuous runs.

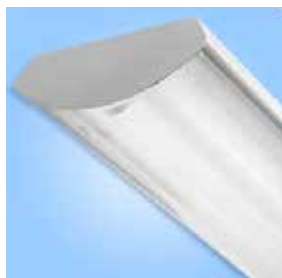

ITEM NO.	DESCRIPTION
USEEWPLR48LS32W3450LDMV40K	9.56"W x 48.0"L x 3.19"H , 32 Watts, 3450 Lumens/ Avail 30K, 35K, 40K, 50K
USEEWPLR48LS48W4800LDMV40K	9.56"W x 48.0"L x 3.19"H , 48 Watts, 4800 Lumens/ Avail 30K, 35K, 40K, 50K
USEEWPLR48LH72W7000LDMV40K	9.56"W x 48.0"L x 3.19"H , 72 Watts, 7200 Lumens/ Avail 30K, 35K, 40K, 50K
USEEWPLR96LS48W4800LDMV40K	9.56"W x 96.0"L x 3.19"H , 48 Watts, 4800 Lumens/ Avail 30K, 35K, 40K, 50K
USEEWPLR96LS65W7000LDMV40K	9.56"W x 96.0"L x 3.19"H , 65 Watts, 7000 Lumens/ Avail 30K, 35K, 40K, 50K
USEEWPLR96LS97W9600LDMV40K	9.56"W x 96.0"L x 3.19"H , 97 Watts, 9600 Lumens/ Avail 30K, 35K, 40K, 50K

For Emergency, add EM. For wiring harness for continuous run, see page 27.

US Energy Services, Inc.

Ph: 512.407.8858 • Email Info Requests and Orders to: Sales@us-energyservices.com
www.us-energyservices.com

SURFACE LINEAR LED

LED WRAPAROUND 7"



Consult for 8ft. LED Wrap.

NEW Frosted Lens

ITEM NO.	SIZE (W X L)
USE207FR224LS24W3100LDMV40K	7.625"W" x 24"L x 3"H / 24W, 3100L, 4000K
USE207FR224LS28W3400LDMV40K	7.625"W" x 24"L x 3"H / 28W, 3400L, 4000K
USE207FR224LF30W3600LDMV40K	7.625"W" x 24"L x 3"H / 30W, 3600L, 4000K
USE207FR248LS32W3450LDMV40K	7.625"W" x 48"L x 3"H / 32W, 3450L, 4000K
USE207FR248LS48W4800LDMV40K	7.625"W" x 48"L x 3"H / 48W, 4800L, 4000K
USE207FR248LS57W5400LDMV40K	7.625"W" x 48"L x 3"H / 57W, 5400L, 4000K
USE207FR448LS65W7000LDMV40K	13"W" x 48"L x 3"H / 65W, 7000L, 4000K
USE207FR448LS97W9600LDMV40K	13"W" x 48"L x 3"H / 97W, 9600L, 4000K
USE207FR448LS114W10800LDMV40K	13"W" x 48"L x 3"H / 114W, 10800L, 4000K

For Emergency, add EM. Available in 3000K, 3500K and 5000K.

LED WRAPAROUND 9"



NEW Frosted Lens



ITEM NO.	SIZE (W X L)	Watts / Lumens	Color Options (X100 Kelvins)
USE209FR48LF32W3450LDMV40K	9" x 48"	32 / 3800	30, 35, 40, 50
USE209FR48LF48W5100LDMV40K	9" x 48"	48 / 5100	30, 35, 40, 50
USE209FR48LF57W6000LDMV40K	9" x 48"	57 / 6000	30, 35, 40, 50
USE209FR48LH72W8200LDMV40K	9" x 48"	72 / 8200	30, 35, 40, 50
USE209A48LF35W3450LDMV40K*	9" x 48"	35 / 3818	30, 35, 40, 50
USE209A48LF48W4800LDMV40K*	9" x 48"	48 / 5107	30, 35, 40, 50
USE209A48LF57W5400LDMV40K*	9" x 48"	57 / 6019	30, 35, 40, 50

For Emergency, add EM

VL LED Wraparound

ITEM NO.	DESCRIPTION
USE207A248LV45W4900LDMV40K	7" x 48" / 45W, 4900L / Color Temp 40
USE209A248LV45W4900LDMV40K	9" x 48" / 45W, 4900L / Color Temp 40

For Emergency, add EM

SPECIFICATION GRADE WIDE WRAPAROUND (4 SIZES)



8 FT Size Available

ITEM NO.	DESCRIPTION
USE200A224LS28W2700LDMV40K	11.25"W x 24"L x 3.4"D 28 Watts, 2700 Lumen ,Avail 30K, 35K, 40K, 50K
USE200A424LS48W4800LDMV40K	15.8"W x 24"L x 3.4"D 48 Watts, 4800 Lumen ,Avail 30K, 35K, 40K, 50K
USE200A248LS48W4800LDMV40K	11.25"W x 48"L x 3.4"D 48 Watts, 4800 Lumen ,Avail 30K, 35K, 40K, 50K
USE200A248LS57W5400LDMV40K	11.25"W x 48"L x 3.4"D 57 Watts, 5400 Lumen ,Avail 30K, 35K, 40K, 50K
USE200A448LS72W8200LDMV40K	15.8"W x 48"L x 3.4"D 72 Watts, 8200 Lumen ,Avail 30K, 35K, 40K, 50K
USE200A296LS97W9600LDMV40K	11.25"W x 96"L x 3.4"D 97 Watts, 9600 Lumen ,Avail 30K, 35K, 40K, 50K
USE200A296LS114W10800LDMV40K	11.25"W x 96"L x 3.4"D 114 Watts, 10800 Lumen ,Avail 30K, 35K, 40K, 50K

For Emergency, add EM

US Energy Services, Inc.

Ph: 512.407.8858 • Email Info Requests and Orders to: Sales@us-energyservices.com

www.us-energyservices.com

SURFACE LINEAR LED



NARROW WRAPAROUND LED (IDEAL FOR CORRIDORS & SMALLER AREAS)

ITEM NO.	DESCRIPTION
USE201A48LS24W2400LDMV40K	5.75"W x 48"L x 4.6"D , 24 Watts, 2400 Lumens/ Avail 30K, 35K, 40K, 50K
USE201A48LS32W3450LDMV40K	5.75"W x 48"L x 4.6"D , 32 Watts, 3450 Lumens/ Avail 30K, 35K, 40K, 50K
USE201A96LS48W4800LDMV40K	5.75"W x 48"L x 4.6"D , 48 Watts, 4800 Lumens/ Avail 30K, 35K, 40K, 50K
USE201A48LH72W7000LDMV40K	5.75"W x 48"L x 4.6"D , 72 Watts, 7200 Lumens/ Avail 30K, 35K, 40K, 50K
USE201A96LS48W4800LDMV40K	5.75"W x 96"L x 4.6"D , 48 Watts, 4800 Lumens/ Avail 30K, 35K, 40K, 50K
USE201A96LS65W7000LDMV40K	5.75"W x 96"L x 4.6"D ,65 Watts, 7000 Lumens/ Avail 30K, 35K, 40K, 50K
USE201A96LS97W9600LDMV40K	5.75"W x 96"L x 4.6"D , 97 Watts, 9600 Lumens/ Avail 30K, 35K, 40K, 50K



CORRIDOR LINEAR

ITEM NO.	DESCRIPTION
USE159A48LS62W6200LDMV40K	4.62"W x 24"L x 4.5"H
USE159A24LS31W3100LDMV40K	4.62"W x 48"L x 4.5"H
USE159A48LS48W4800LDMV40K	4.62"W x 48"L x 4.5"H
USE159A48LS62W6200LDMV40K	4.62"W x 48"L x 4.5"H

LED LINEAR WALL WASHER

Fits neatly into a corner between ceiling and wall to provide general lighting or provides a surface mounted wall wash mounted one third of wall height from the wall.



ITEM NO.	DESCRIPTION
USEW4ASSF48LR24W2400LDMV40KWH	Linear Wall Washer 4"W x 48"L x 4"H, 0-10V Dimmable
USEW4ASSF48LR48W4800LDMV40KWH	Linear Wall Washer 4"W x 48"L x 4"H, 0-10V Dimmable
USEW4ASSF96LR48W4800LDMV40KWH	Linear Wall Washer 4"W x 96"L x 4"H, 0-10V Dimmable
USEW4ASSF96LR96W9600LDMV40KWH	Linear Wall Washer 4"W x 96"L x 4"H, 0-10V Dimmable

Available in 3000K, 3500K and 5000K.

VANDAL PROOF SURFACE MOUNT

Ideal for Locker Rooms and Other High Traffic, Potentially Abusive Applications



ITEM NO.	DESCRIPTION
USELRSFR24LS25W2800LDMV40KWH	12"W x 24"L x 6"D 25 Watts, 2800 Lumens, 0-10V Dimmable Tamper Proof
USELRSFR48LS50W5600LDMV40KWH	12"W x 48"L x 6"D 50 Watts, 5600 Lumens, 0-10V Dimmable Tamper Proof

Available with Clear Lens change FR to CL. or different color temperature change 40K to 30K, 35K 50K. For Emergency, add EM

US Energy Services, Inc.

Ph: 512.407.8858 • Email Info Requests and Orders to: Sales@us-energyservices.com
www.us-energyservices.com

SURFACE LINEAR LED

LED CONTINUOUS RUN LINEAR STRIP COVE LIGHTING (PLUG AND PLAY SYSTEM WITH CORD, PLUG AND BUTT CONNECTOR)



Adjustable and locking mounting bracket aims the light.

ITEM NO.	SIZE (W X L)	Watts / Lumens	Color Options (X100 Kelvins)
USELCR48L18W2400LMV40K*	1" x 48"	18 / 2250	40, 50
USELCR96L40W5200LMV40K*	1" x 96"	40 / 5000	40, 50
USELCRADJMT**	Set of 3		

** Standard brackets included. Not dimmable.

LINKABLE LED STRIP

(EACH FIXTURE COMES WITH 3FT CORD & PLUG, MINI COUPLER AND MOUNTING CLIPS)



ITEM NO.	DESCRIPTION
USELDED13L4W360L50K	STRIP LED DED 4W 360 LUMENS 5000K
USELDED22L7W630L50K	STRIP LED DED 7W 630 LUMENS 5000K
USELDED23L8W720L50K*	STRIP LED DED 8W 720 LUMENS 5000K
USELDED35L14W1260L50K	STRIP LED DED 14W 1260 LUMENS 5000K
USELDED47L18W1550L50K*	STRIP LED DED 18W 1550 LUMENS 5000K
USELDED12JOIN	STRIP LED DED 12in JOINER
USELDED24JOIN	STRIP LED DED 24in JOINER
USELDED6JOIN	STRIP LED DED 6in JOINER
USELDEDJBOX	STRIP LED DED HARDWIRE JBOX

LED STRIP WITH REFLECTOR (IDEAL FOR WALL WASHING)



Asymmetrical reflector provides wall wash (W35 Reflector).

ITEM NO.	DESCRIPTION
USES24LR15W1600LW35DMV40K	24" STRIP ASYMMETRICAL REFLECTOR 15W 1600 LUMENS 4000K
USES48LR29W3200LW35DMV40K	48" STRIP ASYMMETRICAL REFLECTOR 29W 3200 LUMENS 4000K
USES60LR38W4070LW35DMV40K	60" STRIP ASYMMETRICAL REFLECTOR 38W 4070 LUMENS 4000K
USES96LR57W6400LW35DMV40K	96" STRIP ASYMMETRICAL REFLECTOR 57W 6400 LUMENS 4000K

Available in 3000K, 3500K, and 5000K. For continuous run, see wiring harness on page 27.



Shown W65 Reflector, ideal for coves.

Create perimeter lighting and brand image. Consult for custom fixtures and finishes.

US Energy Services, Inc.

Ph: 512.407.8858 • Email Info Requests and Orders to: Sales@us-energyservices.com
www.us-energyservices.com

DECORATIVE LINEAR LED



LOW PROFILE CLOUD (EXCLUSIVELY FOR LED ARRAYS - SHALLOWEST EVER)

ITEM NO.	DESCRIPTION
USELPCMW24LV22W2000LG120*	11" x 24" x 3" / 22W, 2000L / Color Temp 30, 35, 40, 50
USELPCMW48LQ41W4200LG120*	11" x 48" x 3" / 41W, 4200L / Color Temp 30, 35, 40, 50

LOW PROFILE CLOUD (0-10V DIMMING)

USELPCMW24LS20W2250LDMV40K	11" x 24" x 3" / 20W, 2250L / 0-10V Dimming / Color Temp 30, 35, 40, 50
USELPCMW24LS24W2600LDMV40K	11" x 24" x 3" / 24W, 2600L / 0-10V Dimming / Color Temp 30, 35, 40, 50
USELPCMW24LS28W3000LDMV40K	11" x 24" x 3" / 28W, 3000L / 0-10V Dimming / Color Temp 30, 35, 40, 50
USELPCMW48LS40W4550LDMV40K	11" x 48" x 3" / 40W, 4550L / 0-10V Dimming / Color Temp 30, 35, 40, 50
USELPCMW48LS48W5200LDMV40K	11" x 48" x 3" / 48W, 5200L / 0-10V Dimming / Color Temp 30, 35, 40, 50
USELPCMW48LS57W6050LDMV40K	11" x 48" x 3" / 57W, 6050L / 0-10V Dimming / Color Temp 30, 35, 40, 50

*120V only and 2 wire dimming.

ECLIPSE (4 SIZES TO MATCH YOUR APPLICATION)

ITEM NO.	SIZE (W X L)	Watts / Lumens	Color Options (X100 Kelvins)
USEECLMW224LS24W2000DMV40KWH	9.5" x 24"	24 / 2000	30, 35, 40, 50
USEECLMW224LH36W2900LDMV40KWH	9.5" x 24"	36 / 2900	30, 35, 40, 50
USEECLMW424LS48W4000LDMV40KWH	16.5" x 24"	48 / 4000	30, 35, 40, 50
USEECLMW248LS32W2900LDMV40KWH	9.5" x 48"	32 / 2900	30, 35, 40, 50
USEECLMW248LS48W4000LDMV40KWH	9.5" x 48"	48 / 4000	30, 35, 40, 50
USEECLMW248LS57W4500LDMV40KWH	9.5" x 48"	57 / 4500	30, 35, 40, 50
USEECLMW248LH72W5800LDMV40KWH	9.5" x 48"	72 / 5800	30, 35, 40, 50
USEECLMW448LS96W8000LDMV40KWH	16.5" x 48"	96 / 8000	30, 35, 40, 50

Finishes for End Caps: SL-Silver, BM-Black Marble, TO-Tortoise, IM-Ivory, WM-White Marble, WH-White Available in 3000K, 3500K and 5000K.



CONTEMPORARY CLOUD

ITEM NO.	SIZE (W X L)	Watts / Lumens	Color Options (X100 Kelvins)
USECLMMW248LS32W3450LDMV40K	9.75" x 48"	32 / 3450	30, 35, 40, 50
USECLMMW248LS48W4800LDMV40K	9.75" x 48"	48 / 4800	30, 35, 40, 50
USECLMMW248LS57W5400LDMV40K	9.75" x 48"	57 / 5400	30, 35, 40, 50
USECLMMW448LS72W7000LDMV40K	13.75" x 48"	72 / 7200	30, 35, 40, 50
USECLMMW448LS97W9600LDMV40K	13.75" x 48"	97 / 9600	30, 35, 40, 50

Available in 3000K, 3500K and 5000K.



LED Drivers and Dimming

Most of our LED Linear Fixtures have a Multi-Volt 0-10V Dimming Driver designated by DMV. For dimming, use any dimmer that works for 0-10 LED or purchase the Leviton IP710LFZ from us.



Leviton IP710LFZ
IllumaTech Preset
Slide Control

DECORATIVE LINEAR LED

LED PUF SERIES



ITEM NO.	SIZE (W X L)	Watts / Lumens	Color Options (X100 Kelvins)
USEPUF22LS24W2250LDMV40K	17" x 26.5"	24 / 2250	30, 35, 40, 50
USEPUF22LS28W2550LDMV40K	17" x 26.5"	28 / 2550	30, 35, 40, 50
USEPUF424LS32W3450LDMV40K	26.5" x 26.5"	32 / 3450	30, 35, 40, 50
USEPUF424LS48W4800LDMV40K	26.5" x 26.5"	48 / 4800	30, 35, 40, 50
USEPUF248LS32W3450LDMV40K	11" x 48"	32 / 3450	30, 35, 40, 50
USEPUF248LS48W4800LDMV40K	11" x 48"	48 / 4800	30, 35, 40, 50
USEPUF248LS57W5500LDMV40K	11" x 48"	57 / 5500	30, 35, 40, 50
USEPUF248LH72W7000LDMV40K	11" x 48"	72 / 7000	30, 35, 40, 50
USEPUF448LS65W7000LDMV40K	17" x 48"	65 / 7000	30, 35, 40, 50
USEPUF448LS97W9600LDMV40K	17" x 48"	97 / 9600	30, 35, 40, 50
USEPUF448LS114W10800LDMV40K	17" x 48"	114 / 10800	30, 35, 40, 50

For Emergency, add EM for \$188. Available in 3000K, 3500K and 5000K.

LED SPILL RING



Most linear fixtures are dimmable 0-10V.

ITEM NO.	DESCRIPTION
USEFL48LS32W3450LDMV40KSN	11.75"W x 48"L x 4.5"H, 3450lm - 4000K - 0-10V dimmable
USEFL48LS48W4800LDMV40KSN	11.75"W x 48"L x 4.5"H, 4800lm - 4000K - 0-10V dimmable
USEFL48LS57W5400LDMV40KSN	11.75"W x 48"L x 4.5"H, 5400lm - 4000K - 0-10V dimmable
USEFL48LH72W7000LDMV40KSN	11.75"W x 48"L x 4.5"H, 7000lm - 4000K - 0-10V dimmable

Consult for Bronze. For Emergency, add EM. Available in 3000K, 3500K and 5000K.

See matching close-to-ceiling, wall, and bath on pages 25 and 28.

LED CROWN



ITEM NO.	DESCRIPTION
USECRWNMW22LF24W2400LDMV40KWH	CROWN 25"W x 25"L x 4.125"H, 2400lm - 4000K - 0-10V dimmable
USECRWNMW22LF28W2700LDMV40KWH	CROWN 25"W x 25"L x 4.125"H, 2700lm - 4000K - 0-10V dimmable
USECRWNMW22LF35W3200LDMV40KWH	CROWN 25"W x 25"L x 4.125"H, 3450lm - 4000K - 0-10V dimmable
USECRWNMW14LF48W4800LDMV40KWH	CROWN 11.5"W x 48"L x 4.125"H, 4800lm - 4000K - 0-10V dimmable
USECRWNMW14LF57W5700LDMV40KWH	CROWN 11.5"W x 48"L x 4.125"H, 5700lm - 4000K - 0-10V dimmable
USECRWNMW14LH72W7000LDMV40KWH	CROWN 11.5"W x 48"L x 4.125"H, 7000lm - 4000K - 0-10V dimmable
USECRWNMW24LF48W4800LDMV40KWH	CROWN 16.27"W x 48"L x 4.125"H, 4800lm - 4000K - 0-10V dimmable
USECRWNMW24LF57W5700LDMV40KWH	CROWN 16.27"W x 48"L x 4.125"H, 5700lm - 4000K - 0-10V dimmable
USECRWNMW24LH72W7000LDMV40KWH	CROWN 16.27"W x 48"L x 4.125"H, 7000lm - 4000K - 0-10V dimmable

Finishes: WH - White, GO - Golden Oak, UF - Unfinished

US Energy Services, Inc.

Ph: 512.407.8858 • Email Info Requests and Orders to: Sales@us-energyservices.com
www.us-energyservices.com

LINEAR WALL



Available in 3000K, 3500K and 5000K.

See Matching Pendants on page 23.

WALL LINEAR 2" X 3.5" DOWNLIGHT ONLY (ADD U AFTER L FOR UPLIGHT)

ITEM NO.	DESCRIPTION		
USE23WSF48LR26W2600LDMV40KWH	2.00" X 3.50" X 48.00" / 26W, 2600L, 4000K		
USE23WSF48LR38W3800LDMV40KWH	2.00" X 3.50" X 48.00" / 38W, 3800L, 4000K		
USE23WSF48LR45W4500LDMV40KWH	2.00" X 3.50" X 48.00" / 45W, 4500L, 4000K		
USE23WSF96LR52W5200LDMV40KWH	2.00" X 3.50" X 96.00" / 52W, 5200L, 4000K		
USE23WSF96LR76W7600LDMV40KWH	2.00" X 3.50" X 96.00" / 76W, 7600L, 4000K		
USE23WSF96LR90W9000LDMV40KWH	2.00" X 3.50" X 96.00" / 90W, 9000L, 4000K		
Direct/Indirect	Size	Watts Up/Down	Color Options
USE23WSF48LUR12WD24WDMV40KWH	2.00" X 3.50" X 48"	12 / 24	30, 35, 40, 50
USE23WSF48LUR18WD36WDMV40KWH	2.00" X 3.50" X 48"	18 / 36	30, 35, 40, 50
USE23WSF96LUR24WD48WDMV40KWH	2.00" X 3.50" X 96"	24 / 48	30, 35, 40, 50
USE23WSF96LUR36WD72WDMV40KWH	2.00" X 3.50" X 96"	36 / 72	30, 35, 40, 50

Remote Emergency available only. For Emergency, add EM



Available in 3000K, 3500K and 5000K.

WALL LINEAR 4" X 4" DOWNLIGHT ONLY (ADD U AFTER L FOR UPLIGHT)

ITEM NO.	DESCRIPTION
Direct	
USE44WSF48LW24W2400LDMV40KWH	4.00" X 4.00" X 48" / 24W, 2400L, 4000K
USE44WSF48LW48W4800LDMV40KWH	4.00" X 4.00" X 48" / 48W, 4800L, 4000K
USE44WSF96LW48W4800LDMV40KWH	4.00" X 4.00" X 96" / 48W, 4000K, 4000K
USE44WSF96LW96W9600LDMV40KWH	4.00" X 4.00" X 96" / 96W, 9600L, 4000K

For Emergency, add EM. Consult for other finishes.



Available in 3000K, 3500K and 5000K.

WALL LINEAR 4" X 5" DIRECT / INDIRECT

ITEM NO.	Size	Watts Up/Down	Color Options
USE45WSF48LUR12WD24WDMV40KWH	4.00" X 5.50" X 48"	12 / 24	30, 35, 40, 50
USE45WSF48LUR24WD48WDMV40KWH	4.00" X 5.50" X 48"	18 / 36	30, 35, 40, 50
USE45WSF96LUR24WD48WDMV40KWH	4.00" X 5.50" X 96"	24 / 48	30, 35, 40, 50
USE45WSF96LUR36WD72WDMV40KWH	4.00" X 5.50" X 96"	36 / 72	30, 35, 40, 50

For Emergency, add EM



See Matching Pendants or Surface Mounts on page 25.

Available in 3000K, 3500K and 5000K.

NEW Snap Fit Lens

WALL LINEAR 6" X 6"

ITEM NO.	DESCRIPTION		
USE66WSF48LR24W2400LDMV40KWH	6.00" X 6.00" X 48" / 24W, 2400L/ Color Temp - 30, 35, 40, 50		
USE66WSF48LR48W4800LDMV40KWH	6.00" X 6.00" X 48" / 48W, 4800/ Color Temp - 30, 35, 40, 50		
USE66WSF96LR48W4800LDMV40KWH	6.00" X 6.00" X 96" / 48W, 4800/ Color Temp - 30, 35, 40, 50		
USE66WSF96LR97W9600LDMV40KWH	6.00" X 6.00" X 96" / 97W, 9600/ Color Temp - 30, 35, 40, 50		
Direct/Indirect	Size	Watts Up/Down	Color Options
USE66WSF48LUR12WD24WDMV40KWH	6.00" X 6.00" X 48"	12 / 24	30, 35, 40, 50
USE66WSF48LUR24WD48WDMV40KWH	6.00" X 6.00" X 48"	18 / 36	30, 35, 40, 50
USE66WSF96LUR24WD48WDMV40KWH	6.00" X 6.00" X 96"	24 / 48	30, 35, 40, 50
USE66WSF96LUR36WD72WDMV40KWH	6.00" X 6.00" X 96"	36 / 72	30, 35, 40, 50

Change SF to MW for Matte White Lens.

US Energy Services, Inc.

Ph: 512.407.8858 • Email Info Requests and Orders to: Sales@us-energyservices.com
www.us-energyservices.com

LINEAR WALL

WALL LINEAR WINDOW LED WITH DIRECT/INDIRECT LIGHTING



Available in 3000K, 3500K and 5000K.

ITEM NO.	DESCRIPTION		
Downlight Only			
USESLWMW48LS48W4800LDMV40KWH	7.60" x 1.9" x 48" / 48W, 4800L, 4000K		
USESLWMW96LS96W9600LDMV40KWH	7.60" x 1.9" x 96" / 96W, 9600L, 4000K		
Direct/Indirect		Size	Watts Up/Down Color Options
USESLWMW48LUS12WD24WDMV40KWH	7.60" x 1.9" x 48"	12 / 24	30, 35, 40, 50
USESLWMW48LUS18WD36WDMV40KWH	7.60" x 1.9" x 48"	18 / 36	30, 35, 40, 50
USESLWMW96LUS24WD48WDMV40KWH	7.60" x 1.9" x 96"	24 / 48	30, 35, 40, 50
USESLWMW96LUS36WD72WDMV40KWH	7.60" x 1.9" x 96"	36 / 72	30, 35, 40, 50

For Emergency, add EM. Available in variety of finishes.

LINEAR INDIRECT LIGHTING (Not Available Downlight Only)



Louvered (LV)

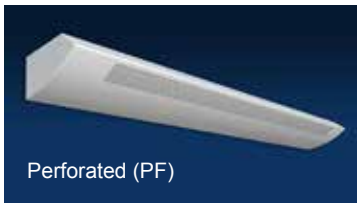

Perforated (PF)



Matte White Lens (MV)

ITEM NO.	SIZE	WATTS/LUMENS	Color Temp (X100 Kelvins)
USEWLINMW48LUS24WD12WDMV40KWH	48"	24W Up 12W Down	30, 35, 40, 50
USEWLINMW48LUS36WD18WDMV40KWH	48"	36W Up 18W Down	30, 35, 40, 50
USEWLINMW96LUS48WD24WDMV40KWH	96"	48W Up 24W Down	30, 35, 40, 50
USEWLINMW96LUS72WD36WDMV40KWH	96"	72W Up 36W Down	30, 35, 40, 50

For 0-10 Dimming. For Emergency, add EM
 Consult for other Direct/Indirect Options. Change WH to BN for Brushed Nickel
 For Louver, change MW to LV
 For Perforated, change MW to PF and deduct

Most fixtures are available in these finishes.



LED 45 DEGREE LINEAR STRIP (IDEAL FOR WALL AND CORNER APPLICATIONS)



ITEM NO.	SIZE	WATTS/LUMENS	Color Temp (X100 Kelvins)
USECU45FR48LFRF35W4500LDMV40K	4.25" x 48"	35W / 4500L	30, 35, 40, 50
USECU45FR48LFRF48W6000LDMV40K	4.25" x 48"	48W / 6000L	30, 35, 40, 50
USECU45FR48LFRF57W7100LDMV40K	4.25" x 48"	57W / 7100L	30, 35, 40, 50
USECU45FR96LFRF70W9100LDMV40K	4.25" x 96"	70W / 9100L	30, 35, 40, 50
USECU45FR96LFRF97W11900LDMV40K	4.25" x 96"	97W / 11900L	30, 35, 40, 50
USECU45FR96LFRF118W14200LDMV40K	4.25" x 96"	118W / 14200L	30, 35, 40, 50

For Emergency, add EM

LINEAR WALL

4" WALL LINEAR



ITEM NO.	SIZE	WATTS/ LUMENS	COLOR OPTIONS (X100 Kelvins)
USE555A24LF24W2400LDMV40KWH	4.3" x 24"	24 / 2400	30, 35, 40, 50
USE555A24LF28W2700LDMV40KWH	4.3" x 24"	28 / 2700	30, 35, 40, 50
USE555A24LF35W3200LDMV40KWH	4.3" x 24"	35 / 3200	30, 35, 40, 50
USE555A48LF30W4100LDMV40KWH*	4.3" x 48"	30 / 4100	30, 35, 40, 50
USE555A48LF48W6000LDMV40KWH*	4.3" x 48"	48 / 6000	30, 35, 40, 50
USE555A48LF57W6900LDMV40KWH*	4.3" x 48"	57 / 6900	30, 35, 40, 50
USE555A48LH72W7000LDMV40KWH	4.3" x 48"	72 / 7000	30, 35, 40, 50

For Matt White Lens, change "A" to "MW".
For Emergency, add EM

4' UP AND DOWN WALL FIXTURE

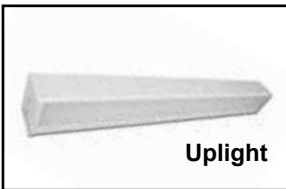

ITEM NO.	SIZE	WATTS/ LUMENS	COLOR OPTIONS (X100 Kelvins)
USE215A24L1U1DS24W2400LDFDMV40K	4.375" x 24.15"L x 5.364"	24 / 2400	30, 35, 40, 50
USE215A24L1U2DS36W3600LDFDMV40K	4.375" x 24.15"L x 5.364"	36 / 3600	30, 35, 40, 50
USE215A24L2U2DS48W4800LDFDMV40K	4.375" x 24.15"L x 5.364"	48 / 4800	30, 35, 40, 50
USE215A24L2U1DS36W3600LDFDMV40K	4.375" x 24.15"L x 5.364"	36 / 3600	30, 35, 40, 50
USE215A48L1U1DS48W4800LDFDMV40K	4.375" x 48"L x 5.364"	48 / 4800	30, 35, 40, 50
USE215A48L1U2DS73W7200LDFDMV40K	4.375" x 48"L x 5.364"	73 / 7200	30, 35, 40, 50
USE215A48L2U2DS97W9600LDFDMV40K	4.375" x 48"L x 5.364"	97 / 9600	30, 35, 40, 50
USE215A48L2U1DS73W7200LDFDMV40K	4.375" x 48"L x 5.364"	73 / 7200	30, 35, 40, 50

For separately switching, add 11 after DMV. 4 way pull chain available.
For Emergency, add EM

LINEAR WALL DOWNLIGHT (IDEAL FOR PERIMETER WALL LIGHTING)



ITEM NO.	SIZE	WATTS/ LUMENS	Color Temp (X100 Kelvins)
USELWDFR48LS30W4100LDMV40K	4.25" x 48"	30 / 4100	30, 35, 40, 50
USELWDFR48LS48W6000LDMV40K	4.25" x 48"	48 / 6000	30, 35, 40, 50
USELWDFR48LS57W6900LDMV40K	4.25" x 48"	57 / 6900	30, 35, 40, 50

For Retrofit Kit see page 51.

US Energy Services, Inc.

Ph: 512.407.8858 • Email Info Requests and Orders to: Sales@us-energyservices.com
www.us-energyservices.com

LINEAR WALL

Stairwell Lighting

Stairwells provide one of the easiest opportunities to provide energy savings. Reduce the light output when no one is in the stairwell and increase light when anyone enters the stairwell.

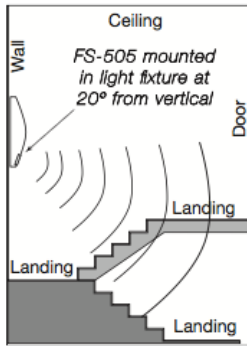

FS-505 Mounted in Stairwell

Ultrasonic technology for open area detection and line-o-sight obstructions.

Choose the percentage of light output (XX) that you want when space is unoccupied.



STAIRWELL STANDARD

ITEM NO.	SIZE (W X L)	Watts / Lumens	Color Options (X100 Kelvins)
USESSSTWFR24LE15W2050LDMV(XX)40K	4.4" x 24"	15 / 2050	30, 35, 40, 50
USESSSTWFR24LE24W3000LDMV(XX)40K	4.4" x 24"	24 / 3000	30, 35, 40, 50
USESSSTWFR48LE48W6000LDMV(XX)40K	4.4" x 48"	48 / 6000	30, 35, 40, 50
USESSSTWFR48LE57W6900LDMV(XX)40K	4.4" x 48"	57 / 6900	30, 35, 40, 50

(XX) for Percentage of Light Output When it is not Occupied. For Emergency, add EM

STAIRWELL LINEAR LED w/ 20% Output and Emergency Unit

ITEM NO.	SIZE	WATTS/LUMENS	COLOR OPTIONS (X100 Kelvins)
USESSSTWFR48LY46W5500LDMV(20)40KEM	4.4" x 48"	46 / 5500	30, 35, 40, 50

Fixed output driver. No variations.

STAIRWELL LINEAR LED WITH STEP DIM DRIVER

(Consult for other Driver Options)



USESSSTR



USESSSTS

ITEM NO.	DESCRIPTION
USESSSTRMW24LE27W2400LDMV(XX)40K	2 ft / 27W, 2400L with Variable Output, Color Temp 30, 35, 40, 50
USESSSTRMW48LE36W3500LDMV(XX)40K	4 ft / 36W, 3500L with Variable Output, Color Temp 30, 35, 40, 50
USESSSTSMW24LE27W2400LDMV(XX)40K	2 ft / 27W, 2400L with Variable Output, Color Temp 30, 35, 40, 50
USESSSTSMW48LE36W3500LDMV(XX)40K	4 ft / 36W, 3500L with Variable Output, Color Temp 30, 35, 40, 50

(XX) for Percentage of Light Output When it is not Occupied. For Emergency, add EM

STAIRWELL LINEAR LED WITH STEP DIM DRIVER

(Consult for other Driver Options)



ITEM NO.	SIZE	WATTS/LUMENS	COLOR OPTIONS (X100 Kelvins)
USESS213A24LE15W2050LDMV(XX)40K	4.4" x 24"	15 / 2050	30, 35, 40, 50
USESS213A24LE24W3000LDMV(XX)40K	4.4" x 24"	24 / 3000	30, 35, 40, 50
USESS213A48LE48W6000LDMV(XX)40K	4.4" x 48"	48 / 6000	30, 35, 40, 50
USESS213A48LE57W6900LDMV(XX)40K	4.4" x 48"	57 / 6900	30, 35, 40, 50
USESS213A48LY40W4000LDMV(20)40KEM	4.4" x 48"	48 / 6000	30, 35, 40, 50

(XX) for Percentage of Light Output When it is not Occupied.

US Energy Services, Inc.

Ph: 512.407.8858 • Email Info Requests and Orders to: Sales@us-energyservices.com
www.us-energyservices.com

LINEAR WALL



ROUNDED LINEAR LOW PROFILE

New Shallow style works with a standard 4.25" backbox with a sleek, rounded diffuser. Easy to use in a variety of sizes and great value.

ITEM NO.	DESCRIPTION
USEFSFFR48LF31W3100LDMV40KWH	2.36"W x 47.25"L x 2.83"H / 31W, 3100L, 4000K
USEFSFFR48LF57W5900LDMV40KWH	2.36"W x 47.25"L x 2.83"H / 57W, 5900L, 4000K
USEFSFFR96LF62W6200LDMV40KWH	2.36"W x 94.43"L x 2.83"H / 62W, 6200L, 4000K
USEFSFFR96LF114W11700LDMV40KWH	2.36"W x 94.43"L x 2.83"H / 114W, 11700L, 4000K

For Sensor Option add **SM** or **MDT4** in front See Retrofit Kit on page 50
For Emergency add **EM**

LED SPILL RING BATH



ITEM NO.	DESCRIPTION
USEHOTBD24L23W2195LMVSN30K	24.5"L x 5.7"W x 4.5"E 23W, 2195 Lumens 3000K, Multi-Volt Satin Nickel
USEHOTBD36L34W3260LMVSN30K	36.5"L x 5.7"W x 4.5"E 34W, 3261 Lumens 3000K, Multi-Volt Satin Nickel
USEHOTBD48L48W4590LMVSN30K	48.5"L x 5.7"W x 4.5"E 48W, 4594 Lumens 3000K, Multi-Volt Satin Nickel

Consult for Bronze ends. Also available in 40K.

VAN SERIES



ITEM NO.	DESCRIPTION
USEVAN24LS24W2250LDMV40KSW	4.75" x 4.00" x 24.125" / 24W, 2250L, 4000K
USEVAN24LS28W2550LDMV40KSW	4.75" x 4.00" x 24.125" / 28W, 2550L, 4000K
USEVAN48LS32W3250LDMV40KSW	4.75" x 4.00" x 48.125" / 32W, 3250L, 4000K
USEVAN48LS48W4500LDMV40KSW	4.75" x 4.00" x 48.125" / 48W, 4500L, 4000K
USEVAN48LS57W5100LDMV40KSW	4.75" x 4.00" x 48.125" / 57W, 5100L, 4000K

Change SW to **BM** (Black Marble), **IV** (Ivory Marble), etc for end cap in different finish. See specification for more end cap choices. Available in 3000K, 3500K and 4000K.
Add after **USEVAN**, **WR** for White Ribbed, **CR** - Clear Ribbed, **FR** - For Frosted Ribbed.

WALL PUFF SERIES



ITEM NO.	DESCRIPTION
USEWPU24LS24W2250LDMV40K	27" x 6" x 2.75" 24 Watt, 2250 Lumens, Available in 3000K, 3500K, 5000K
USEWPU48LS48W4500LDMV40K	51" x 6" x 2.75" 48 Watt, 4500 Lumens, Available in 3000K, 3500K, 5000K

For Emergency, add **EM**

See Other Options for Wall Mounting in Linear Strip Section, Pages 18-23.

US Energy Services, Inc.

Ph: 512.407.8858 • Email Info Requests and Orders to: Sales@us-energyservices.com
www.us-energyservices.com

LED UNDERCABINET

LED Linkable Undercabinet



ITEM NO.	DESCRIPTION
USELUC9L5WE120	9" LED undercabinet lights, Dimmable, linkable, 5w
USELUC12L6WE120	12" LED undercabinet lights, Dimmable, linkable, 6w
USELUC18L9WE120	18" LED undercabinet lights, Dimmable, linkable, 9w
USELUC24L11WE120	24" LED undercabinet lights, Dimmable, linkable, 11w
USELUC33L13WE120	33" LED undercabinet lights, Dimmable, linkable, 13w
USELUC42L16WE120	42" LED undercabinet lights, Dimmable, linkable, 16w

Undercabinets come with power cord, joiner cable, butt connector and a BX connector.

LED Dimmable Undercabinet Task Lighting



ITEM NO.	SIZE	WATTS / LUMENS	COLOR OPTIONS (x100) Kelvins
USELEDDUCL12WH30	2" 12"	5 / 250	30
USELEDDUCL18WH30	2" x 18"	8 / 400	30
USELEDDUCL24WH30	2" x 24"	11 / 525	30
USELEDDUCLJBOXWH	Junction Box for hardwire		

Each fixture comes with mini coupler and 15" joiner cord, 42" cord and plug with integral on/off switch.

LED HIGH LUMEN TAPE



ITEM NO.	DESCRIPTION
USET5050L24V27K*	LED HIGH LUMEN TAPE 1ft PIECES, 4.32W/FT, 180LM/FT, 24v, 27K
USET5050L24V30K*	LED HIGH LUMEN TAPE 1ft PIECES, 4.32W/FT, 185LM/FT, 24v, 30K
USET5050L24V40K*	LED HIGH LUMEN TAPE 1ft PIECES, 4.32W/FT, 189LM/FT, 24v, 40K
UETHWCON10	LED 10 foot HARDWIRE CONNECTOR
USETEXT4IN	LED 4 inch 4 PIN TAPE JUMPER CABLE MtoF
USETEXT12IN	LED 12 inch 4 PIN TAPE JUMPER CABLE MtoF
USETEXT36IN	LED 36 inch 4 PIN TAPE JUMPER CABLE MtoF
USETCON4M4M	LED 4 PIN TAPE MALE to MALE CONNECTOR
USETTCON	LED 4 PIN TAPE MALE to MALE T CONNECTOR

*Priced per Foot, 15ft/Reel. Specify remote driver.

REMOTE DRIVER (Dimmable with any standard MLV Triac (leading edge) control)



ITEM NO.	DESCRIPTION	Watts
USEMTIM60L24DC	Magnitude Magnetic Driver 60W 24VDC Encased	60
USEMTIM100L24DC	Magnitude Magnetic Driver 96W 24VDC Encased	96
USEMTIM150L24DC	Magnitude Magnetic Driver 150W 24VDC Encased	150

Consult for other drivers and wattages.

US Energy Services, Inc.

Ph: 512.407.8858 • Email Info Requests and Orders to: Sales@us-energyservices.com
www.us-energyservices.com

LED RETROFITS

LED Retrofit All-In-One Retrofit LED Troffer Kit

Convert an existing linear fluorescent fixture to a state-of-the-art Linear LED fixture in minutes with this LED All-In-One Retrofit Kit. Choose from two great styles of Linear LED fixtures that will not only increase lighting performance, save energy and reduce maintenance but provide a fresh new look for the space. The LED Center Basket All-In-One Retrofit provides the look of a popular direct/indirect linear fixture with a special designed reflector and LED lens to provide comfortable, abundant lighting. The Chicklet Retrofit Kit provides a luminous pillow styled lens and a high level of lighting with a dramatic appearance. Each kit mounts in minutes with all the LED components neatly engineered in one simple frame that mounts to two side rails that mount between the existing fixture body and the T-bar. Available in 2x2 or 2x4 sizes and a variety of wattage, lumens and color temperatures.



Install in Minutes:
Place Rails between fixture and T-Bar on each side. Then latch and secure All-In-One-LED-Retrofit into place.

CENTER BASKET

ITEM NO.	ITEM NO.
USEDFUCLL22LF24W3000LDMV40K*	Door Frame Center Basket Retro 2x2 24W, 2400 Lumen, 40K, 0-10V Dimming Capable
USEDFUCLL22LF28W3350LDMV40K*	Door Frame Center Basket Retro 2x2 28W, 2800 Lumen, 40K, 0-10V Dimming Capable
USEDFUCLL22LF35W4300LDMV40K*	Door Frame Center Basket Retro 2x2 32W, 3200 Lumen, 40K, 0-10V Dimming Capable
USEDFUCLL24LF32W4650LDMV40K*	Door Frame Center Basket Retro 2x4 32W, 3200 Lumen, 40K, 0-10V Dimming Capable
USEDFUCLL24LF48W6750LDMV40K*	Door Frame Center Basket Retro 2x4 48W, 4800 Lumen, 40K, 0-10V Dimming Capable
USEDFUCLL24LF57W7800LDMV40K*	Door Frame Center Basket Retro 2x4 57W, 5700 Lumen, 40K, 0-10V Dimming Capable
USEDFUCLL24LF62W8100LDMV40K*	Door Frame Center Basket Retro 2x4 62W, 8100 Lumen, 40K, 0-10V Dimming Capable

For other color temperatures, replace 40K with 30K, 35K or 50K.
Consult for other wattage and lumen options and emergency driver.
Consult for 1x4 version.

CHICKLET FROSTED LENS

ITEM NO.	ITEM NO.
USEDFCKFR22LF24W2400LDMV40K*	Door Frame Chicklet Frosted Lens Retro 2x2 24W, 2400 Lumen, 40K, 0-10V Dimming Capable
USEDFCKFR22LF28W2800LDMV40K*	Door Frame Chicklet Frosted Lens Retro 2x2 28W, 2800 Lumen, 40K, 0-10V Dimming Capable
USEDFCKFR22LF32W3200LDMV40K*	Door Frame Chicklet Frosted Lens Retro 2x2 32W, 3200 Lumen, 40K, 0-10V Dimming Capable
USEDFCKFR24LF32W3200LDMV40K*	Door Frame Chicklet Frosted Lens Retro 2x4 32W, 3200 Lumen, 40K, 0-10V Dimming Capable
USEDFCKFR24LF40W4000LDMV40K*	Door Frame Chicklet Frosted Lens Retro 2x4 40W, 4000 Lumen, 40K, 0-10V Dimming Capable
USEDFCKFR24LF48W4800LDMV40K*	Door Frame Chicklet Frosted Lens Retro 2x4 48W, 4800 Lumen, 40K, 0-10V Dimming Capable
USEDFCKFR24LF57W5700LDMV40K*	Door Frame Chicklet Frosted Lens Retro 2x4 57W, 5700 Lumen, 40K, 0-10V Dimming Capable



For other color temperatures, replace 40K with 30K, 35K or 50K.
Consult for other wattage and lumen options and emergency driver.
Consult for 1x4 version.

For Large Quantities, Call or Email us for a Quote

US Energy Services, Inc.

Ph: 512.407.8858 • Email Info Requests and Orders to: Sales@us-energyservices.com
www.us-energyservices.com

LED RETROFITS

Retrofit Your Store To Stand Out and Save Energy



LED Troffer Retrofit Kit Makes Sally Beauty Stand Out.



VL LED CENTER BASKET RETROFIT

ITEM NO.	DESCRIPTION
USERKCB22L36W4680LDMV40K*	22.52" x 20.67" x 2.6" / 36W, 4680 Lumens, 4000K
USERKCB22L36W4680LDMV50K*	22.52" x 20.67" x 2.6" / 36W, 4680 Lumens, 5000K
USERKCB24L36W4900LDMV40K	20.67" x 47.8" x 2.6" / 36W, 4902 Lumens, 4000K
USERKCB24L36W4900LDMV50K	20.67" x 47.8" x 2.6" / 36W, 4902 Lumens, 5000K

For Emergency, add EM



Consult for Parabolic Retrofit Kit



LED TROFFER RETROFIT KIT

(INSTALLS IN FLUORESCENT TROFFER IN UNDER 5 MINUTES)

ITEM NO.	DESCRIPTION
USE22CF24W2600LW10DMV40K*	2x2 / 24W, 2600L / Color Temp - 30, 35, 40, 50
USE22CF28W3000LW10DMV40K*	2x2 / 28W, 3000L / Color Temp - 30, 35, 40, 50
USE22CF35W3600LW10DMV40K*	2x2 / 35W, 4400L / Color Temp - 30, 35, 40, 50
USE24CF35W3650LW10DMV40K*	2x4 / 35W, 3650L / Color Temp - 30, 35, 40, 50
USE24CF48W5650LW10DMV40K*	2x4 / 48W, 5650L / Color Temp - 30, 35, 40, 50
USE24CF56W6050LW10DMV40K*	2x4 / 56W, 6050L / Color Temp - 30, 35, 40, 50

For Emergency, add EM



LED TROFFER RETROFIT KIT w/INTEGRAL SENSOR

ITEM NO.	DESCRIPTION
USESM22CLY28W2850LVDMV40K	2x2 / 28W, 2850L / Color Temp - 30, 35, 40, 50 w/Integral Occupancy Sensor
USESM24CLY56W5650LVDMV40K	2x4 / 56W, 5650L / Color Temp - 30, 35, 40, 50 w/Integral Occupancy Sensor

VL LED TROFFER RETROFIT

ITEM NO.	DESCRIPTION
USE24CV46W6200LDMV40K	2x4 / 46W, 6200L / Color Temp 40

Fixed output driver. No variations.

US Energy Services, Inc.

Ph: 512.407.8858 • Email Info Requests and Orders to: Sales@us-energyservices.com
www.us-energyservices.com

LED Strip Retrofit Kits



WARNING: If you have this fixture in 4 or 8 Foot, You can Retrofit Them and Save over 40% Energy and Reduce Maintenance.

LED STRIP RETROFIT KIT ROUND PROFILE



Complete fixture available. Add "C" in front of item number and

ITEM NO.	DESCRIPTION
USERSR48LT20W2700LDMV40K	4.25" 48" Strip LED Round Frost Lens 20W 2700 Lumens 4000K
USERSR48LT30W3450LDMV40K	4.25" 48" Strip LED Round Frost Lens 30W 3450 Lumens 4000K
USERSR48LT41W4300LDMV40K	4.25" 48" Strip LED Round Frost Lens 41W 4300 Lumens 4000K
USERSR48LT58W6700LDMV40K	4.25" 48" Strip LED Round Frost Lens 58W 6700 Lumens 4000K
USERSR96LT40W4700LDMV40K	4.25" 96" Strip LED Round Frost Lens 40W 4700 Lumens 4000K
USERSR96LT60W6900LDMV40K	4.25" 96" Strip LED Round Frost Lens 60W 6900 Lumens 4000K
USERSR96LT82W8900LDMV40K	4.25" 96" Strip LED Round Frost Lens 82W 8900 Lumens 4000K
USERSR96LT116W13400LDMV40K	4.25" 96" Strip LED Round Frost Lens 116W 13400 Lumens 4000K

For Emergency, add EM. Available in 3000K, 3500K, and 5000K.

LED STRIP RETROFIT KIT FLAT PROFILE



Complete fixture available. Add "C" in front of item number and add \$15 per 4 foot

ITEM NO.	DESCRIPTION
USERSF48LT20W2700LDMV40K	4.25" 48" Strip LED Flat Frost Lens 20W 2700 Lumens 4000K
USERSF48LT30W3450LDMV40K	4.25" 48" Strip LED Flat Frost Lens 30W 3450 Lumens 4000K
USERSF48LT41W4300LDMV40K	4.25" 48" Strip LED Flat Frost Lens 41W 4300 Lumens 4000K
USERSF48LT58W6700LDMV40K	4.25" 48" Strip LED Flat Frost Lens 58W 6700 Lumens 4000K
USERSF96LT40W4700LDMV40K	4.25" 96" Strip LED Flat Frost Lens 40W 4700 Lumens 4000K
USERSF96LT60W6900LDMV40K	4.25" 96" Strip LED Flat Frost Lens 60W 6900 Lumens 4000K
USERSF96LT82W18900LDMV40K	4.25" 96" Strip LED Flat Frost Lens 82W 8900 Lumens 4000K
USERSF96LT116W13400LDMV40K	4.25" 96" Strip LED Flat Frost Lens 116W 13400 Lumens 4000K

For Emergency, add EM. Available in 3000K, 3500K and 5000K. Consult to retrofit 5" strip.

ENCLOSED STRIP RETROFIT KIT BEST VALUE



ITEM NO.	DESCRIPTION
USERFSFFR24LF12W1400LDMV40K	4.25" x 3.5" x 24.00" / 12W, 1400L, 4000K
USERFSFFR48LF24W2800LDMV40K	4.25" x 3.5" x 48.00" / 24W, 2800L, 4000K
USERFSFFR48LF48W4800LDMV40K	4.25" x 3.5" x 48.00" / 48W, 4800L, 4000K
USERFSFFR48LHF57W5900LDMV40K	4.25" x 3.5" x 48.00" / 57W, 5900L, 4000K
USERFSFFR96LF62W6200LDMV40K	4.25" x 3.5" x 96.00" / 62W, 6200L, 4000K
USERFSFFR96LHF114W11700LDMV40K	4.25" x 3.5" x 96.00" / 114W, 11700L, 4000K

For Emergency, add EM for. Available in 3000K, 3500K and 5000K. Consult to retrofit 5" strip.

US Energy Services, Inc.

Ph: 512.407.8858 • Email Info Requests and Orders to: Sales@us-energyservices.com
www.us-energyservices.com

LED RETROFITS

LED STRIP BALLAST COVER RETROFIT KIT (FOR 4.25" OR 5" STRIPS)



Frosted lens accessory reduces LED brightness. C48FRLN - \$17

ITEM NO.	SIZE (W X L)	Watts / Lumens	Color Options (X100 Kelvins)
USE4RB421F24W3250LDMV40K	4.25" x 48"	24 / 3250	30, 35, 40, 50
USE4RB421F48W6500LDMV40K	4.25" x 48"	48 / 6500	30, 35, 40, 50
USE4RB421F57W6900LDMV40K	4.25" x 48"	57 / 6900	30, 35, 40, 50
USE4RB501F24W3250LDMV40K	5" x 48"	24 / 3250	30, 35, 40, 50
USE4RB501F48W6500LDMV40K	5" x 48"	48 / 6500	30, 35, 40, 50
USE4RB501F57W7800LDMV40K	5" x 48"	57 / 6900	30, 35, 40, 50
USE8RB421F48W6500LDMV40K	4.25" x 96"	48 / 6500	30, 35, 40, 50
USE8RB421F97W13000LDMV40K	4.25" x 96"	97 / 13000	30, 35, 40, 50
USE8RB421F114W15600LDMV40K	4.25" x 96"	114 / 15600	30, 35, 40, 50
USE8RB501F48W6500LDMV40K	5" x 96"	48 / 6500	30, 35, 40, 50
USE8RB501F97W13000LDMV40K	5" x 96"	97 / 13000	30, 35, 40, 50
USE8RB501F114W15600LDMV40K	5" x 96"	114 / 15600	30, 35, 40, 50

For Emergency, add EM

LINEAR WALL DOWN RETROFIT (IDEAL TO RETROFIT PERIMETER WALL LIGHTING)



Fully Luminous Lens for beautiful look.

ITEM NO.	SIZE	WATTS/ LUMENS	Color Temp (X100 Kelvins)
USERLWDFR48LS30W4100LDMV40K	4.25" x 48"	30 / 4100	30, 35, 40, 50
USERLWDFR48LS48W6000LDMV40K	4.25" x 48"	48 / 6000	30, 35, 40, 50
USERLWDFR48LS57W6900LDMV40K	4.25" x 48"	57 / 6900	30, 35, 40, 50

See complete fixture on page 44.

CTC / WALL FIXTURE RETROFITS (AC WITH DRIVER ON BOARD AND HEAT SINK)



ITEM NO.	DESCRIPTION
USEEOS12W900LD12030KSQ	EOS Array w/6" Sq Alum Heat Sink - 12W, 900L, 3000K
USEEOS12W1000LD12040KSQ	EOS Array w/6" Sq Alum Heat Sink - 12W, 1000L, 4000K
USEEOS15W1350LD12030KSQ	EOS Array w/8" Sq Alum Heat Sink - 15W, 1350L, 3000K
USEEOS15W1400LD12040KSQ	EOS Array w/8" Sq Alum Heat Sink - 15W, 1400L, 4000K
USEEOS22W1850LD12030KSQ	EOS Array w/8" Sq Alum Heat Sink - 22W, 1850L, 3000K
USEEOS22W1900LD12040KSQ	EOS Array w/8" Sq Alum Heat Sink - 22W, 1900L, 4000K

Dimmable with standard dimmer. UL Classified for retrofit.



CTC RETROFIT FOR 11" OR 14" WITH HEAT SINK (DIMMABLE W/STANDARD DIMMER)

ITEM NO.	DESCRIPTION
USEDAC15W1350LD12030K	LED Array 120V for 11" CTC 15W, 1350L / Color Temp 30, 40, 50
USEDAC25W1850LD12030K	LED Array 120V for 14" CTC 25W, 1850L / Color Temp 30, 40, 50

US Energy Services, Inc.

Ph: 512.407.8858 • Email Info Requests and Orders to: Sales@us-energyservices.com
www.us-energyservices.com

LED C-T-C



LED SPILL RING CLOSE-TO-CEILING

ITEM NO.	DESCRIPTION
USEHOTCD12L18W1400LMVSN30K	11.8"D x 4.2"H 18W, 1439 Lumens, 3000K, Multi-Volt Satin Nickel
USEHOTCD14L24W2250LMVSN30K	14.5"D x 4.6"H 24W, 2267 Lumens, 3000K, Multi-Volt Satin Nickel*
USEHOTCD18L33W3300LMVSN30K	11.8"D x 4.2"H 33W, 3300 Lumens, 3000K, Multi-Volt Satin Nickel

Consult for 16 inch Version. For 4000K change 30K to 40K



CTC 11" TWIST LOCK BRUSHED NICKEL LED 120V (DIMMABLE)

ITEM NO.	DESCRIPTION
USEHTCA11L15W800LD12040KBN	11" Brushed Nickel/Frosted Glass 15W, 800L, 4000K, Dimmable 120V, 50000 Hrs

Change 40K to 30K or 50K. While quantities last.



CTC 11" & 14" SLEEK BRUSHED NICKEL LED 120V (DIMMABLE)

ITEM NO.	DESCRIPTION
USEHTCB11L15W900LD12040KBN	11" Brushed Nickel/Polycarbonate Diffuser 15W, 900L 4000K, Dimmable 120V, 50000 Hrs
USEHTCB14L25W1200LD12040KBN	14" Brushed Nickel/Polycarbonate Diffuser 25W, 1200L 4000K, Dimmable 120V, 50000 Hrs

Change 40K to 30K or 50K. While quantities last.



CTC 11" & 14" MUSHROOM LED 120V (DIMMABLE)

ITEM NO.	DESCRIPTION
USEMUS11L15W1000LD12040K	11" Mushroom White/Polycarbonate Diffuser 15W, 1000L 4000K, Dimmable 120V, 50000 Hrs
USEMUS14L25W1600LD12040K	14" Mushroom White/Polycarbonate Diffuser 25W, 1600L 4000K, Dimmable 120V, 50000 Hrs

Change 40K to 30K or 50K. While quantities last.

LED DRUM FIXTURE



ITEM NO.	DESCRIPTION
USECIRDC11L13W900LD12030K	11" Drum 13W 900 Lumens, Dimmable 120V 3000K
USECIRDC11L14W1350LD12030K	11" Drum 14W 1350 Lumens, Dimmable 120V 3000K
USECIRDC14L14W1350LD12030K	14" Drum 14W 1350 Lumens, Dimmable 120V 3000K
USECIRDC14L23W1850LD12030K	14" Drum 23W 1850 Lumens, Dimmable 120V 3000K

Consult for multi-volt and other wattage and lumen options.

LED MUSHROOM FIXTURE



ITEM NO.	DESCRIPTION
USETFC11L13W900LD12030K	11" Mushroom 13W 900 Lumens, Dimmable 120V 3000K
USETFC11L14W1350LD12030K	11" Mushroom 14W 1350 Lumens, Dimmable 120V 3000K
USETFC14L14W1350LD12030K	14" Mushroom 14W 1350 Lumens, Dimmable 120V 3000K
USETFC14L23W1850LD12030K	14" Mushroom 23W 1850 Lumens, Dimmable 120V 3000K

Change 30K to 40K for 4000K. Consult for multi-volt and other wattage and lumen options.

US Energy Services, Inc.

Ph: 512.407.8858 • Email Info Requests and Orders to: Sales@us-energyservices.com
www.us-energyservices.com

LED C-T-C / DISK LIGHTS

LED DOME FIXTURE



ITEM NO.	DESCRIPTION
USEHOTCE11L13W900LD12030K	11" Dome 13W 900 Lumens, Dimmable 120V 3000K
USEHOTCE11L14W1350LD12030K	11" Dome 14W 1350 Lumens, Dimmable 120V 3000K
USEHOTCE14L14W1350LD12030K	14" Dome 14W 1350 Lumens, Dimmable 120V 3000K
USEHOTCE14L23W1850LD12030K	14" Dome 23W 1850 Lumens, Dimmable 120V 3000K

Change 30K to 40K for 4000K. Consult for multi-volt and other wattage and lumen options

ULTRA THIN FAUX DOWNLIGHT (WET LOCATION)

Choose either a round or square silhouette in two sizes and two finishes, white and brushed nickel with a special regressed lens to provide even, comfortable illumination from these edge-lit fixtures. Wet location for indoor and outdoor use. 120V only. Dims to 10% with standard dimmers.



ITEM NO.	DESCRIPTION
USERCS5L10W660L30KWH	Square 6.3 inches Diagonal, 10W, 660 Lumens, 3000K, 120V, White
USERCS5L10W660L30KBN	Square 6.3 inches Diagonal, 10W, 660 Lumens, 3000K 120V, Brushed Nickel
USERCS7L15W1000L30KWH	Square 8.0 inches Diagonal, 15W, 1000 Lumens, 3000K, 120V, White
USERCS7L15W1000L30KBN	Square 8.0 inches Diagonal, 15W, 1000 Lumens, 3000K, 120V, Brushed Nickel
USERCR5L10W660L30KWH	Round, 5.5 inches Diameter, 10W, 660 Lumens, 3000K, 120V White
USERCR5L10W660L30KBN	Round, 5.5 inches Diameter, 10W, 660 Lumens, 3000K, 120V Brushed Nickel
USERCR7L15W1000L30KWH	Round, 7.0 inches Diameter, 15W, 1000 Lumens, 3000K, 120V White
USERCR7L15W1000L30KBN	Round, 7.0 inches Diameter, 15W, 1000 Lumens, 3000K, 120V Brushed Nickel

MICRO LED SURFACE MOUNT (WET LOCATION)



ITEM NO.	DESCRIPTION
USES4L12W900L30KWH	4" (5.9" OD) White, 12W 876L, CRI > 80, 3000K, 120V, with 20W Dimmable Driver. Surface Mount.
USES6L15W1100L30KWH	6" (7.4" OD) White, 15W 1095L, CRI > 80, 3000K, 120V, Dimmable Driver. Surface Mount.
USES9L26W2100L30KWH	9" Diameter, 26W, 2100 Lumen, 30K in White Dimmable Driver, Surface Mount
USES4RECACC	Recessed Accessory Kit to Retro SMC4L Series into 4" Recessed White Can Housings
USES6RECACC	Recessed Accessory Kit to Retro SMC6L Series into 6" Recessed White Can Housings

Consult for bronze and satin nickel. Also available in 9 inch version - 26 watt.

Call or Email us for a Quote

US Energy Services, Inc.

Ph: 512.407.8858 • Email Info Requests and Orders to: Sales@us-energyservices.com
www.us-energyservices.com

LED C-T-C / DISK LIGHTS



SMC EMERGENCY AND 277V VERSION

ITEM NO.	DESCRIPTION
USESMC6L15W1100L30KWH-277V	Surface Disc in 277V 15W, 1100L, 30K in White
USESMC6L15W1100L30KWH-EM	Surface Disc with Integral Emergency Back-Up in recessed junction Box; 15W 1100L; EM mode 6w 400L 3000K White

Emergency version comes with junction box.

MICRO ECONOMY LED SURFACE MOUNT



ITEM NO.	DESCRIPTION
USELMC6L15W1000L12030KWH	Surface Mount LED 15W 1000L, Dimmable. 35000 Hours. 7.4"OD x 1.26"H, White
USELMC6L15W1000L12030KBN	Surface Mount LED 15W 1000L, Dimmable. 35000 Hours. 7.4"OD x 1.26"H, Brushed Nickel

SURFACE DISCS 11" AND 15"



ITEM NO.	DESCRIPTION
USESMC11L28W1700LD12030KBN	SURFACE Disc 11" Dia LED 28W 1700 lumen BN
USESMC11L28W1700LD12030KWH	SURFACE Disc 11" Dia LED 28W 1700 lumen WH
USESMC15L40W2500LD12030KBN	SURFACE Disc 15" Dia LED 40W 2500 lumen BN
USESMC15L40W2500LD12030KWH	SURFACE Disc 15" Dia LED 40W 2500 lumen WH

STYLISH AND REALLY ECONOMICAL LED DISK, IDEAL FOR C-T-C



ITEM NO.	DESCRIPTION
USETDL6L15W1100L30KWH	7 3/8"D x 1 1/2"H DISK LIGHT 15W/1100 Lumen 120V AC 3000K WHITE
USETDL6L15W1100L30KBA	7 3/8"D x 1 1/2"H DISK LIGHT 15W/1100 Lumen 120V AC 3000K BRUSHED ALUMINUM
USETDL6L15W1100L30KBZ	7 3/8"D x 1 1/2"H DISK LIGHT 15W/1100 Lumen 120V AC 3000K BRONZE
USETDL6RECACC	Recessed Accessory Kit for TDLG

Change 30K to 40K

ENCLOSURES/OUTDOOR

Acrylic Lens Options	2ft	4ft	8ft
RF Ribbed Frosted	✓	✓	✓
LB Linear Ribbed	✓	✓	✓
CL Clear Shallow		✓	
FR Frosted Shallow		✓	
OL Clear Deep Lens	✓	✓	✓
FL Frosted Deep Lens	✓	✓	✓

*Add "P" in front of Lens options above for Polycarbonate. Consult for pricing adders on these.



Deep Lens not available for USECITN.



Standard 3/4" hub allows standard electrical accessories for installation.



ENCLOSURES LOW BAY (WET LOCATION)

ITEM NO.	SIZE (W X L)	Watts / Lumens	Color Options (X100 Kelvins)
USECITE24LFRF24W2700LLBDMV40K	7.3" x 26.6"	24 / 2700	30, 35, 40, 50
USECITE24LFRF28W3300LLBDMV40K	7.3" x 26.6"	28 / 3300	30, 35, 40, 50
USECITE48LFRF48W5600LLBDMV40K*	7.3" x 51.8"	48 / 5600	30, 35, 40, 50
USECITE48LFRF57W6800LLBDMV40K*	7.3" x 51.8"	57 / 6800	30, 35, 40, 50
USECITE96LFRF97W11200LLBDMV40K	7.3" x 98.5"	97 / 11200	30, 35, 40, 50
USECITE96LFRF114W13600LLBDMV40K	7.3" x 98.5"	114 / 13600	30, 35, 40, 50

For emergency, add EM. Consult for sensors. Consult for stainless steel latches. **Consult for New Narrow Economy Version 48 inch.**

ENCLOSURES PARKING GARAGE (WET LOCATION)

ITEM NO.	SIZE (W X L)	Watts / Lumens	Color Options (X100 Kelvins)
USECITE48LRF48W4500LPGDMV40K	7.3" x 51.8"	48 / 4500	30, 35, 40, 50
USECITE48LRF57W5100LPGDMV40K	7.3" x 51.8"	57 / 5100	30, 35, 40, 50
USECITE48LRFH72W7000LPGDMV40K	7.3" x 51.8"	72 / 7000	30, 35, 40, 50
USECITE96LRF57W5100LPGDMV40K	7.3" x 98.5"	57 / 5100	30, 35, 40, 50
USECITE96LRF97W9050LPGDMV40K	7.3" x 98.5"	97 / 9050	30, 35, 40, 50

For emergency, add EM. Consult for sensors. Consult for stainless steel latches.

LED VAPORTIGHT

ITEM NO.	SIZE (W X L)	Watts / Lumens	Color Options (X100 Kelvins)
USECITN48LRF48W5600LLBDMV40K	4.4" x 51.8"	48 / 5600	30, 35, 40, 50

OUTDOOR SIGN LIGHTER W/ 3/4" HUB (WET LOCATION)

ITEM NO.	DESCRIPTION
USEOSL48LS48W4800LDMV40K	54.5"L x 5.25"W x 3.06"H, Aluminum Extrusion with Clear Lens 48W / 4800L
USEOSL48LS57W5700LDMV40K	54.5"L x 5.25"W x 3.06"H, Aluminum Extrusion with Clear Lens 57W / 5700L
USEOSL96LS96W9600LDMV40K	102.5"L x 5.25"W x 3.06"H, Aluminum Extrusion with Clear Lens 96W / 9600L
USEOSL96LS114W11400LDMV40K	102.5"L x 5.25"W x 3.06"H, Aluminum Extrusion with Clear Lens 114W / 11400L

LED AQUAGUARD

ITEM NO.	DESCRIPTION
USELAG48L47W6890LDMV50KWH	48.25"L x 6.625"Dia, Extruded Acrylic Housing with Clear Prismatic Lens, 47W / 6888Lm, Strain Relief and 4' 16/3 STW Black Cordset

LINEAR VANDAL RESISTANT

ITEM NO.	DESCRIPTION
USECV800LF48W4800LMV50K	50.25"L X 8.25"W X 4.5"H 48 System Watts, 4800 Delivered Lumens 5000K
USECV800LH72W7200LMV50K	50.25"L X 8.25"W X 4.5"H 48 System Watts, 4800 Delivered Lumens 5000K

Available in 4000K and White Finish. Consult Factory for Custom Finish.

US Energy Services, Inc.

Ph: 512.407.8858 • Email Info Requests and Orders to: Sales@us-energyservices.com
www.us-energyservices.com

OUTDOOR



LED CANOPY WET LOCATION

ITEM NO.	SIZE (W x L)
USECPY10L45W4200LDMV50K*	CANOPY LED - 45W-4200 Lumen - 100-277V - 5000K-CR170 - Finish: Bronze - uL/CuL/DLC
USECPY10L65W6600LDMV50K*	CANOPY LED - 65W - 6000 Lumen - 100-277V- 5000K - Finish: Bronze - uL/CuL/DLC



LED LARGE CANOPY

ITEM NO.	DESCRIPTION
USECV30012L53W6250LDMV50KBZ	12Inch Square , Clear Lens, 53W / 6267Lm, 50K, Bronze Finish

Available in 4000K and White Finish. Consult Factory for Custom Finish.



LED GARAGE LIGHTER

ITEM NO.	DESCRIPTION
USELGL56W5500LDMV50KBZ	13.75"L x 11.25"W x 2.5"H, 56W / 5537Lm, 5000K, Bronze Finish

Available in 4000K and White Finish. Consult Factory for Custom Finish and Sensor Option.



LED SQUARE BULKHEADS WET LOCATION (DIE CAST)

ITEM NO.	DESCRIPTION
USEGSC16L125W14950LDMV50KWH	Gas Station Canopy, 16.5"L x 16.5"W x 7.75"H, 125W / 14952Lm, 5000K, White Finish
USEGSC20L204W27300LDMV50KWH	Gas Station Canopy, 19.875"L x 19.875"W x 7.75"H, 204W / 27301Lm, 5000K, White Finish

GOOSNECK BELL FIXTURE

ITEM NO.	DESCRIPTION
USEGBF81W7200LMV50KGY	23"L x 15"H x 7.50"Dia/ 40W, 4000L/ 120-277V / 40K/GRAY FINISH
USEGBFARM	GOOSNECK MOUNTING ARM

See Spec Sheet for all Arm and finish options.



OUTDOOR

Outdoor Wet Location Wall/Ceiling (Bug Proof) IP65



ITEM NO.	DESCRIPTION
USEOUTMW15W1200LD120BK40K	LED Round 12" diameter - Black 120V only 1200 Lumens 4000K
USEOUTMW15W1200LD120BK30K	LED Round 12" diameter - Black 120V only 1200 Lumens 3000K
USEOUTMW15W1200LD120WH40K	LED Round 12" diameter -White 120V only 1200 Lumens 4000K
USEOUTMW15W1200LD120WH30K	LED Round 12" diameter -White 120V only 1200 Lumens 3000K

For eyelid change USEOUT to USEOUTEY

LED ROUND BULKHEADS WET LOCATION (DIE CAST)



ITEM NO.	DESCRIPTION
USERBO20W1650LDMV50KBZ	Open Frame, 12.5"Dia x 3.94"H, LumaLens, 20W / 1674Lm, 5000K, Bronze Finish
USERBG20W1950LDMV50KBZ	Grid Frame, 12.5"Dia x 4.375"H, LumaLens, 20W / 1976Lm, 5000K, Bronze Finish
USERBH20W1450LDMV50KBZ	Half Cutoff, 12.5"Dia x 4.375"H, LumaLens, 20W / 1467Lm, 5000K, Bronze Finish

Available in 4000K and White Finish. Consult Factory for Custom Finish.

LED SQUARE BULKHEADS WET LOCATION (DIE CAST)



ITEM NO.	DESCRIPTION
USESBO20W1600LDMV50KBZ	Open Frame, 12.5"L x 12.5"W x 3.94"H, LumaLens, 20W / 1614Lm, 5000K, Bronze Finish
USESBG20W1900LDMV50KBZ	Grid Frame, 12.5"L x 12.5"W x 4.25"H, LumaLens, 20W / 1923Lm, 5000K, Bronze Finish
USESBH20W1550LDMV50KBZ	Half Cutoff, 12.5"L x 12.5"W x 4.25"H, LumaLens, 20W / 1570Lm, 5000K, Bronze Finish

Available in 4000K and White Finish. Consult Factory for Custom Finish.



(Turtle Friendly)

WALL CYLINDERS LED

ITEM NO.	DESCRIPTION
USEWCD10LINCWH	Wall Mount Tall Cylinder- w/Medium Socket White 120V
USEWCD8LINCWH	Wall Mount Short Cylinder-w/Medium Socket - White 120V

For Black change WH to BK. Lamps sold separately. Ideal for LED Par 30 Lamp

US Energy Services, Inc.

Ph: 512.407.8858 • Email Info Requests and Orders to: Sales@us-energyservices.com
www.us-energyservices.com

OUTDOOR



USEF1303 - Round



USEF1302 - Square



WET LOCATION CLOSE-TO-CEILING

ITEM NO.	DESCRIPTION
USEF13032INCLPLEDWH	ROUND CEILING WET 2Incand. socket & LED Lamp 9.5W A19 27K Incl. White Dimmable 120V
USEF1303L23W1900LD120WH40K	ROUND CEILING WET 23W 1900L White Dimmable 120V
USEF1303L22W1824LMVWH40K	ROUND CEILING WET 22W 1824L White Multi-Volt
USEF13022INCLPLEDWH	SQUARE CEILING WET 2 Incand. socket & LED Lamp 9.5W A19 27K Incl. White Dimmable 120V
USEF1302L23W1900LD120WH40	SQUARE CEILING WET 23W 1900L White Dimmable 120V
USEF1302L22W1824LMVWH40K	SQUARE CEILING WET 22W 1824L White Multi-Volt

For 3000K change 40K to 30K. For Black body, change WH to BK. See LED Lamp spec on page 61.

OUTDOOR OCTAGON SERIES



ITEM NO.	DESCRIPTION
USEOCLINCLPLEDWH	OCTAGON CEILING Incand. socket & LED Lamp 9.5W A19 27K Incl. White Dimmable 120V
USEOCL10L14W1400LD120WH40K	OCTAGON CEILING 14W 1400L White Dimmable 120V
USEOCL10L23W1900LD120WH40K	OCTAGON CEILING 23W 1900L White Dimmable 120V

For 3000K change 40K to 30K. For Black, change WH to BK



LED VAPOR PROOF

ITEM NO.	DESCRIPTION
USEVPC6L14W900LMV50K	CEILING MOUNT VAPOR PROOF LED VPC, 8.75X12.1, 14W, 900L 120-277V DRIVER, 5000K
USEVPW6L14W900LMV50K	VAPORPROOF LED WALL MOUNT - FROST GLASS - 14W 900 LUMEN 5000K, 120-277V



WALL CYLINDER

ITEM NO.	DESCRIPTION
USEWCWD20W2300LDMV40KBZ	Wide Optic, 100 Degree, 8.875"L x 5.75"Dia x 10.25"H, Down Light, 20W / 2313Lm, 4100K, Bronze Finish
USEWCWU20WD20W4350LDMV40KBZ	Wide Optic, 100 Degree, 8.875"L x 5.75"Dia x 12.25"H, Up and Down Light, 40W / 4347Lm, 4100K, Bronze Finish

For Up light only, change "D" to "U". Available in Black Finish, change "BZ" to "BK"

OUTDOOR CEILING

SQUARE CEILING LED



ITEM NO.	DESCRIPTION
USECBPINCLPLEDWH	8.25" SQUARE Ceiling Incand. socket & LED Lamp 9.5W A19 27K Incl. White Dimmable 120V
USECBPL13W1000LD120WH40K	8.25" SQUARE CEILING 13W 1000L White Dimmable 120V
USECBPL11W912LMVWH40K	8.25" SQUARE CEILING 11.3W 912L White Multi-Volt



ITEM NO.	DESCRIPTION
USEBBPINCLPLEDWH	10.25" SQUARE Ceiling Incand. socket & LED Lamp 9.5W A19 27K Incl. White Dimmable 120V
USEBBPL23W1900LD120WH40K	10.25" SQUARE CEILING 23W 1900L White Dimmable 120V
USEBBPL22W1824LMVWH40K	10.25" SQUARE CEILING 22W 1824L White Multi-Volt

For Black base lamp change WH to BK

CEILING GLOBES



ITEM NO.	DESCRIPTION
USEBCCINCLPLEDWHCAG	CEILING MOUNT 6" SCREW NECK GLOBE-Incand. socket & LED Lamp 9.5W A19 27K Incl. - White Dimmable 120V



ITEM NO.	DESCRIPTION
USEBPCINCLPLEDWHWAG	CEILING MOUNT 6" SCREW NECK GLOBE TAPER-Incand. socket & LED Lamp 9.5W A19 27K Incl. - White Dimmable 20V

For Black base lamp change WH to BK

CYLINDER CLASSIC GLOBES



ITEM NO.	DESCRIPTION
USEBCCINCLPLEDWHWSJ	CEILING MOUNT HARBOR SCREW NECK-Incand. socket & LED Lamp 9.5W A19 27K Incl. - White Dimmable 120V

ITEM NO.	DESCRIPTION
USEWPCINCLPLEDWHCSJ	CEILING MOUNT HARBOR SCREW NECK TAPER-Incand. socket & LED Lamp 9.5W A19 27K Incl. - White Dimmable 20V



ITEM NO.	DESCRIPTION
USEBPCINCLPLEDWHWPJ	CEILING MOUNT LONG BEACH TAPER-Incand. socket & LED Lamp 9.5W A19 27K Incl.- White Dimmable 120V

For Black base lamp change WH to BK. For other lens options, consult factory.



ITEM NO.	DESCRIPTION
USEF1010CLAC2INCLPLED	SQUARE SENTINEL 2 Incand. socket & LED Lamp 9.5W A19 27K Incl. White, Dimmable 120V
USEF1010CLAC10L14W1400LD12040K	SQUARE SENTINEL, 10.25 SQ.14W 1400L White Dimmable 120V
USEF1010CLAC10L23W1900LD12040K	SQUARE SENTINEL, 10.25 SQ. 23W 1900L White Dimmable 120V

US Energy Services, Inc.

Ph: 512.407.8858 • Email Info Requests and Orders to: Sales@us-energyservices.com
www.us-energyservices.com

OUTDOOR WALL



UTILITY LED

ITEM NO.	DESCRIPTION
USESWPFRACINCLPLED	Small Wall Pack 5" x 8" Incand. socket & LED Lamp 9.5W A19 27K Incl. White Dimmable 120V
USESWPFRACL13W1000LD12040K	Small Wall Pack 13W 1000L White Dimmable 120V
USEMWPFRACINCLPLED	Medium Wall Pack, Incand. socket & LED Lamp 9.5W A19 27K Incl. White 6" x 10.8" Dimmable 120V
USEMWPFRACL13W1000LD12040K	Medium Wall Pack 13W 1000L White Dimmable 120V
USELWPFR15W1500LMV40K	Large Wall Pack Clear Lens 15W 1500L Multi-Volt 40K

For 3000K change 40K to 30K

LED NAUTICAL WALL OR CEILING



USECEO



ITEM NO.	DESCRIPTION
USEEOINCLPLEDWH	Euro Oval Wall or Ceiling Incand. socket & LED Lamp 9.5W A19 27K Incl. White Dimmable 120V
USECEOL13W1000LD120WH40K	Euro Oval Wall or Ceiling 13W 1000L White Dimmable 120V
USECEOL11W912LMVWH40K	Euro Oval Wall or Ceiling 11.3W 912L White Multi-Volt



USECEOG

USEEOGINCLPLEDWH	Euro Oval Wall or Ceiling Incand. socket & LED Lamp 9.5W A19 27K Incl. White Dimmable 120V
USECEOGL13W1000LD120WH40K	Euro Oval Wall or Ceiling w/Grill 13W 1000L White Dimmable 120V
USECEOGL11W912LMVWH40K	Euro Oval Wall or Ceiling w/Grill 11.3W 912L White Multi-Volt



USECEOS



USECEOC

USEEOSINCLPLEDWH	Euro Oval Wall or Ceiling Incand. socket & LED Lamp Incl. White Dimmable 120V
USECEOSL13W1000LD120WH40K	Euro Oval Wall or Ceiling w/Eyelid 13W 1000L White Dimmable 120V
USECEOSL11W912LMVWH40K	Euro Oval Wall or Ceiling 11.3W 912L White Multi-Volt

For Full Grill change USEEOS to USEEOC and USECEO to USECEOC



USECER



ITEM NO.	DESCRIPTION
USEERLINCLPLEDWH	Euro Round Wall or Ceiling Incand. socket & LED Lamp Incl. White Dimmable 120V
USECERL23W1900LD120WH40K	Euro Round Wall or Ceiling 23W 1900L White Dimmable 120V
USECERL22W1824LMVWH40K	Euro Round Wall or Ceiling 22W 1824L White Multi-Volt



USECERG



USEERGINCLPLEDWH	Euro Round Wall or Ceiling w/Grill-9.5W A19 27K-White dimmable 120V
USECERGL23W1900LD120WH40K	Euro Round Wall or Ceiling w/Grill 23W 1900L White Dimmable 120V
USECERGL22W1824LMVWH40K	Euro Round Wall or Ceiling w/Grill 22W 1824L White Multi-Volt



USECERC



USEERCINCLPLEDWH	Euro Round Wall or Ceiling w/Mask-9.5W A19 27K-White dimmable 120V
USECERCL23W1900LD120WH40K	Euro Round Wall or Ceiling w/Mask 23W 1900L White Dimmable 120V
USECERCL22W1824LMVWH40K	Euro Round Wall or Ceiling w/Mask 22W 1824L White Multi-Volt

US Energy Services, Inc.

Ph: 512.407.8858 • Email Info Requests and Orders to: Sales@us-energyservices.com

www.us-energyservices.com

OUTDOOR

NAUTICAL LANTERNS AND POST TOPS



USENOB



ITEM NO.	DESCRIPTION
USENOBINCLPLEDWH	Nautical Bollard-9.5W A19 27K - White Dimmable 120V
USENOBL13W1000LD120WH40K	Nautical Bollard 12W 1000L White Dimmable 120V



USENOP



USENOP2INCLPLEDWH	Double Nautical Post-9.5W A19 27K - White Dimmable 120V
USENOP2L26W2000LD120WH40K	Double Nautical Post 26W 2000L White Dimmable 120V
USENOPINCLPLEDWH	Single Nautical Post-9.5W A19 27K - White Dimmable 120V
USENOPL11W912LMVWH40K	Single Nautical Post 11.3W 912L White Multi-volt
USENOPL13W1000LD120WH40K	Single Nautical Post 13W 1000L White Dimmable 120V
USENOPL22W1824LMVWH40K	Double Nautical Post 22W 1824L White Multi-volt



USENOW



USENOWINCLPLEDWH	Nautical Wall Incand. socket & LED Lamp 9.5W A19 27K incl. White Dimmable 120V
USENOWL11W912LMVWH40K	Nautical Wall 11.3W 912L White Multi-volt
USENOWL13W1000LD120WH40K	Nautical Wall 13W 1000L White Dimmable 120V

For 3000K change 40K to 30K. For Black, change WH to BK
Energy Star not available on Post Lanterns

LED GLOBE LANTERNS AND POST TOPS



USEGP12



ITEM NO.	DESCRIPTION
USEGOWINCLPLEDWH	8" Globe Wall Mount - Incand. socket & LED Lamp 9.5W A19 27K incl. - White Dimmable 120V
USEGP10INCLPLEDWH	10" Globe Post Top - Incand. socket & LED Lamp 9.5W A19 27K incl. - White Dimmable 120V
USEGP12INCLPLEDWH	12" Globe Post Top - Incand. socket & LED Lamp 9.5W A19 27K incl. - White Dimmable 120V
USEGP14INCLPLEDWH	14" Globe Post Top - Incand. socket & LED Lamp 9.5W A19 27K incl. - White Dimmable 120V
USEGP16INCLPLEDWH	16" Globe Post Top - Incand. socket & LED Lamp 9.5W A19 27K incl. - White Dimmable 120V



USEGOW

USEGP10

For 3000K change 40K to 30K. For Black, change WH to BK

Energy Star not available on Post Lanterns

Consult for traditional Acorn and Flame Top Post Tops in clear or frosted finishes

BRADFORD LED LANTERNS AND POST TOPS



USEBRP

USEBRL



ITEM NO.	DESCRIPTION
USEBRLINCLPLEDWH	Bradford Long Wall - Incand. socket & LED Lamp 9.5W A19 27K incl. - White Dimmable 120V
USEBRLL13W1000LD120WH40K	Bradford Long Wall 13W 1000L White Dimmable 120V
USEBRPINCLPLEDWH	Bradford Post Top Incand. socket & LED Lamp incl. White Dimmable 120V
USEBRPL13W1000LD120WH40K	Bradford Post Top 13W1000L White Dimmable 120V
USEBRWINCLPLEDWH	Bradford Short Wall-9.5W A19 27K White Dimmable 120V
USEBRWL13W1000LD120WH40K	Bradford Short Wall 13W 1000L White Dimmable 120V



USEBRW

Energy Star not available on Post Lanterns

LED A19/E26

- 9.5W
- 800 Lumens 120V 2700K
- Replaces 60W Incandescent or 13W CFL
- CRI 80
- 15,000 Hour Life
- 270 Beam Angle, Dimmable

Consult for 4000K Lamp

NOTE: Now fixtures with LED A Lamps can qualify for Energy Star



US Energy Services, Inc.

OUTDOOR



COLONIAL LED LANTERNS AND POST TOPS

ITEM NO.	DESCRIPTION
USECOLINCLPLEDWH	Colonial Long Wall - Flemish Lens - Incand. socket & LED Lamp 9.5W A19 27K incl. - White Dimmable 120V
USECOLL13W1000LD120WH40K	Colonial Long Wall - Flemish Lens 13W 1000L, White Dimmable 120V
USECOPL13W1000LD120WH40K	Colonial Post Top - Flemish Lens 13W 1000L, White Dimmable 120V
USECOWINCLPLEDWH	Colonial Short Wall - Flemish Lens - Incand. socket & LED Lamp 9.5W A19 27K incl. White Dimmable 120V
USECOWL13W1000LD120WH40K	Colonial Short Wall - Flemish Lens 13W 1000L, White Dimmable 120V

For 3000K change 40K to 30K. For Black, change WH to BK. See A Lamp specs on page 61.
Energy Star not available on Post Lanterns



PRINCETON LED LANTERNS AND POST TOPS

ITEM NO.	DESCRIPTION
USEPRLINCLPLEDWH	Princeton Long Wall - Incand. socket & LED Lamp 9.5W A19 27K incl. - White Dimmable 120V
USEPRL13W1000LD120WH40K	Princeton Long Wall 13W 1000L, White Dimmable 120V
USEPRPINCLPLEDWH	Princeton Post Top - Incand. socket & LED Lamp 9.5W A19 27K incl. - White Dimmable 120V
USEPRPL13W1000LD120WH40K	Princeton Post Top 13W 1000L White Dimmable 120V
USEPRWINCLPLEDWH	Princeton Short Wall - Incand. socket & LED Lamp 9.5W A19 27K incl. White Dimmable 120V
USEPRWL13W1000LD120WH40K	Princeton Short Wall 13W 1000L, White Dimmable 120V

For 3000K change 40K to 30K. For Black, change WH to BK. See A Lamp specs on page 61.
Energy Star not available on Post Lanterns



STAGECOACH LED LANTERN

ITEM NO.	DESCRIPTION
USESCWINCLPLEDWH	Wall Mount Stage Coach - Incand. socket & LED Lamp 9.5W A19 27K incl. - White Dimmable 120V
USESCWL13W1000LD120WH40K	Wall Mount 13W 1000L White Dimmable 120V

For 3000K change 40K to 30K. For Black, change WH to BK. See A Lamp specs on page 61.
Energy Star not available on Post Lanterns



ECONOMY WALL

ITEM NO.	DESCRIPTION
USEAPWINCLPLEDWH	Wall Mount Small Acorn - Incand. socket & LED Lamp 9.5W A19 27K incl. - White Dimmable 120V
USEAPWL11W912LMVWH40K	Wall Mount Small Acorn 13W 912L, White Multi-volt
USEAPWL13W1000LD120WH40K	Wall Mount Small Acorn 13W 1000L, White Dimmable 120V
USEDHINCLPLEDWH	Wall Mount Cottage - Incand. socket & LED Lamp 9.5W A19 27K incl. - White Dimmable 120V
USEDHL13W1000LD120WH40K	Wall Mount Cottage 13W 1000L White Dimmable 120V

See A Lamp specs on page 61.

Energy Star not available on Post Lanterns Add Photocell to all LED wall versions - PC120

US Energy Services, Inc.

Ph: 512.407.8858 • Email Info Requests and Orders to: Sales@us-energyservices.com
www.us-energyservices.com

AMHERST LED LANTERNS AND POST TOPS



ITEM NO.	DESCRIPTION
USEAOLINCLPLEDWH	Amherst Long Wall - Incand. socket & LED Lamp 9.5W A19 27K incl. - White Dimmable 120V
USEAOLL13W1000LD120WH40K	Amherst Long Wall 13W 1000L, White Dimmable 120V
USEAOPINCLPLEDWH	Amherst Post Top w/Incand. socket & LED Lamp 9.5W A19 27K incl. White Dimmable 120V
USEAOP13W1000LD120WH40K	Amherst Post Top 13W 1000L, White Dimmable 120V
USEAOWINCLPLEDWH	Amherst Short Wall - Incand. socket & LED Lamp 9.5W A19 27K incl. - White Dimmable 120V
USEAOWL13W1000LD120WH40K	Amherst Short Wall 13W 1000L White Dimmable 120V

For 3000K change 40K to 30K. For Black, change WH to BK. See A Lamp specs on page 61. **Energy Star not available on Post Lanterns**

HEXAGON LED LANTERNS AND POST TOPS



ITEM NO.	DESCRIPTION
USEHOPINCLPLEDWH	Hexagon Post Top - Incand. socket & LED Lamp 9.5W A19 27K incl. - White Dimmable 120V
USEHOPL13W1000LD120WH40K	Hexagon Post Top 13W 1000L, White Dimmable 120V
USEHOWINCLPLEDWH	Hexagon Short Wall-9.5W A19 27K -White Dimmable 120V
USEHOWL13W1000LD120WH40K	Hexagon Short Wall 13W 1000L, White Dimmable 120V
USEHOLINCLPLEDWH	Hexagon Long Wall - White Dimmable 120V
USEHOLL13W1000LD120WH40K	Hexagon Long Wall 13W 1000L White Dimmable 120V

For 3000K change 40K to 30K. For Black, change WH to BK. See A Lamp specs on page 61. **Energy Star not available on Post Lanterns**

HATCH LED LANTERNS AND POST TOPS



ITEM NO.	DESCRIPTION
USEHTPINCLPLEDWH	Post Top Hatch - Incand. socket & LED Lamp 9.5W A19 27K incl. - White Dimmable 120V
USEHTPL13W1000LD120WH40K	Post Top Hatch 13W 1000L, White Dimmable 120V
USEHTWINCLPLEDWH	Petite Hatch - Incand. socket & LED Lamp 9.5W A19 27K incl. - White Dimmable 120V
USEHTWL13W1000LD120WH40K	Petite Hatch 13W 1000L, White Dimmable 120V
USEHTSINCLPLEDWH	Short Hatch - Incand. socket & LED Lamp incl. White Dimmable 120V
USEHTSL13W1000LD120WH40K	Short Hatch 13W 1000L White Dimmable 120V
USEHTLINCLPLEDWH	Long Hatch - Incand. socket & LED Lamp 9.5W A19 27K incl. - White Dimmable 120V
USEHTLL13W1000LD120WH40K	Long Hatch 13W 1000L White Dimmable 120V

For 3000K change 40K to 30K. For Black, change WH to BK. See A Lamp specs on page 61. **Energy Star not available on Post Lanterns**

KINGSTON LED LANTERNS AND POST TOPS



ITEM NO.	DESCRIPTION
USEKRLINCLPLEDWH	KINGSTON LONG WALL-Incand. socket & LED Lamp 9.5W A19 27K Incl. - White Dimmable 120V
USEKRLL13W1000LD120WH40K	KINGSTON LONG WALL 13W 1000L White Dimmable 120V
USEKRPINCLPLEDWH	KINGSTON POST TOP Incand. socket & LED Lamp 9.5W A19 27K Incl. White Dimmable 120V
USEKRPL13W1000LD120WH40K	KINGSTON POST TOP 13W 1000L White Dimmable 120V
USEKRWINCLPLEDWH	KINGSTON SHORT WALL-Incand. socket & LED Lamp 9.5W A19 27K Incl. - White Dimmable 120V
USEKRWL13W1000LD120WH40K	KINGSTON SHORT WALL 13W 1000L White Dimmable 120V

For 3000K change 40K to 30K. For Black, change WH to BK. See A Lamp specs on page 61. **Energy Star not available on Post Lanterns**

US Energy Services, Inc.

Ph: 512.407.8858 • Email Info Requests and Orders to: Sales@us-energyservices.com
www.us-energyservices.com

OUTDOOR

TUDOR LED POST TOPS



ITEM NO.	DESCRIPTION
USETOLINCLPLEDBK*	Tudor Long Wall - Incand. socket & LED Lamp 9.5W A19 27K incl. - Black Dimmable 120V
USETOLL13W1000LD120BK40K*	Tudor Long Wall 13W 1000L, Black Dimmable 120V
USETOPINCLPLEDWH	Tudor Post Top w/Incand. socket & LED Lamp 9.5W A19 27K incl. White Dimmable 120V
USETOPL13W1000LD120WH40K	Tudor Post Top 13W 1000L, White Dimmable 120V
USETOP10INCLPLEDWH	10.5" IMPERIAL POST TOP-Incand. socket & LED Lamp 9.5W A19 27K Incl. - White Dimmable 120V
USETOP10L23W1900LD120WH40K	10.5" IMPERIAL POST TOP23W 1900L White Dimmable 120V
USETOP13INCLPLEDWH	13" IMPERIAL POST TOP-Incand. socket & LED Lamp 9.5W A19 27K Incl. - White Dimmable 120V
USETOP13L23W1900LD120WH40K	13" IMPERIAL POST TOP 23W 1900L White Dimmable 120V
USETOPINCLPLEDBK*	LARGE TUDOR POST TOP-Incand. socket & LED Lamp 9.5W A19 27K Incl. - Black Dimmable 120V
USESTOPL13W1000LD120BK40K*	LARGE TUDOR POST TOP13W 1000L Black Dimmable 120V
USETOLINCLPLEDBK*	LARGE TUDOR WALL-Incand. socket & LED Lamp 9.5W A19 27K Incl. - Black Dimmable 120V
USETOLL13W1000LD120BK40K*	LARGE TUDOR WALL13W 1000L Black Dimmable 120V

For 3000K change 40K to 30K. For Black, change WH to BK. See LED A19 Specs on page 61.
*Not available in White

HARBOUR LED WALL MOUNT



ITEM NO.	DESCRIPTION
USEBPWINCLPLEDWHWPJ	WALL MOUNT HARBOR-Incand. socket & LED Lamp 9.5W A19 27K Incl.- White Dimmable 120V
USEBPWL13W1000LD120WH40KWSJ	WALL MOUNT HARBOR13W 1000L White Dimmable 120V
USEBPWL11W912LMVWH40KWSJ	WALL MOUNT HARBOR11.3W 912L White Multi-Volt

For 3000K change 40K to 30K. For Black, change WH to BK. See LED A19 Specs on page 61.

LONG BEACH LED WALL MOUNT



ITEM NO.	DESCRIPTION
USEBPWINCLPLEDWHWPJ	WALL MOUNT LONG BEACH-9.5W A19 27K - White Dimmable 120V
USEBPWL13W1000LD120WH40KWPJ	WALL MOUNT LONG BEACH13W 1000L White Dimmable 120V
USEBPWL11W912LMVWH40KWPJ	WALL MOUNT LONG BEACH11.3W 912L White Multi-Volt

For 3000K change 40K to 30K. For Black, change WH to BK. See LED A19 Specs on page 61.

CLASSIC LED WALL POCKET



ITEM NO.	DESCRIPTION
USEWPWINCLPLEDWHWAG	WALL MOUNT 6" GLOBE-9.5W A19 27K - White Dimmable 120V
USEWPWL13W1000LD120WH40KWAG	WALL MOUNT 6" GLOBE13W 1000L White Dimmable 120V
USEWPWL11W912LMVWH40KWAG	WALL MOUNT 6" GLOBE11.3W 912L White Multi-Volt

For 3000K change 40K to 30K. For Black, change WH to BK. See LED A19 Specs on page 61.
Add Photocell to all LED wall versions - PC120

US Energy Services, Inc.

Ph: 512.407.8858 • Email Info Requests and Orders to: Sales@us-energyservices.com
www.us-energyservices.com

OUTDOOR

DUSK TO DAWN



ITEM NO.	DESCRIPTION
USED2D10L40W4000LMV50KGY	23"L x 15"H x 7.50"Dia/ 40W, 4000L/ 120-277V / 50K/ GRAY FINISH
USED2D12L45W4900LMV50KBZ	20.69"L x 17.73"H x 8.98"Dia/ 45W, 4900L/ 120-277V / 50K / BRONZE FINISH

LED LINEAR WALLPACK



ITEM NO.	DESCRIPTION
USELWOC12L26W3300LDMV50KGY	Open Frame, 12"L x 7"W x 4"H, CLEAR LENS, 26W / 3332Lm, 5000K, GRAY FINISH
USELWOL12L26W2950LDMV50KGY	Open Frame, 12"L x 7"W x 4"H, LumaLens, 26W / 2945Lm, 5000K, GRAY FINISH
USELWOC12L43W5500LDMV50KGY	Open Frame, 12"L x 7"W x 4"H, CLEAR LENS, 43W / 5538Lm, 5000K, GRAY FINISH
USELWOL12L43W4950LDMV50KGY	Open Frame, 12"L x 7"W x 4"H, LumaLens, 43W / 4948Lm, 5000K, GRAY FINISH
WÜÖLWOC24L58W7300LDMV50KGY	Open Frame, 24"L x 7"W x 4"H, CLEAR LENS, 58W / 7309Lm, 5000K, GRAY FINISH
WÜÖLWOL24L58W5950LDMV50KGY	Open Frame, 24"L x 7"W x 4"H, LumaLens, 58W / 5932Lm, 5000K, GRAY FINISH
WÜÖLWOC24L77W10300LDMV50KGY	Open Frame, 24"L x 7"W x 4"H, CLEAR LENS, 77W / 10294Lm, 5000K, GRAY FINISH
USELWOL24L77W8350LDMV50KGY	Open Frame, 24"L x 7"W x 4"H, LumaLens, 77W / 8356Lm, 5000K, GRAY FINISH
USELWOC48L126W16290LDMV50KGY	Open Frame, 48"L x 7"W x 4"H, CLEAR LENS, 126W / 162812Lm, 5000K, GRAY FINISH
USELWOL48L126W13700LDMV50KGY	Open Frame, 48"L x 7"W x 4"H, LumaLens, 126W / 13720Lm, 5000K, GRAY FINISH
USELWOC48L152W19750LDMV50KGY	Open Frame, 48"L x 7"W x 4"H, CLEAR LENS, 152W / 19773Lm, 5000K, GRAY FINISH
USELWOL48L152W16600LDMV50KGY	Open Frame, 48"L x 7"W x 4"H, LumaLens, 152W / 16594Lm, 5000K, GRAY FINISH
USELWHC12L26W3330LDMV50KGY	Horizontal Hood, 12"L x 7"W x 4"H, CLEAR LENS, 26W / 3332Lm, 5000K, GRAY FINISH
USELWHL12L26W2950LDMV50KGY	Horizontal Hood, 12"L x 7"W x 4"H, LumaLens, 26W / 2945Lm, 5000K, GRAY FINISH
USELWHC12L43W5500LDMV50KGY	Horizontal Hood, 12"L x 7"W x 4"H, CLEAR LENS, 43W / 5538Lm, 5000K, GRAY FINISH
USELWHL12L43W4950LDMV50KGY	Horizontal Hood, 12"L x 7"W x 4"H, LumaLens, 43W / 4948Lm, 5000K, GRAY FINISH
USELWVC12L26W3300LDMV50KGY	Vertical Hood, 12"L x 7"W x 4"H, CLEAR LENS, 26W / 3332Lm, 5000K, GRAY FINISH
USELWWL12L26W2950LDMV50KGY	Vertical Hood, 12"L x 7"W x 4"H, LumaLens, 26W / 2945Lm, 5000K, GRAY FINISH
USELWVC12L43W5500LDMV50KGY	Vertical Hood, 12"L x 7"W x 4"H, CLEAR LENS, 43W / 5538Lm, 5000K, GRAY FINISH
USELWWL12L43W4950LDMV50KGY	Vertical Hood, 12"L x 7"W x 4"H, LumaLens, 43W / 4948Lm, 5000K, GRAY FINISH

WEDGE FULL CUT OFF WALL PACK FIXTURE

ITEM NO.	DESCRIPTION
USES-EESWPC20LEDUNVPS25W50K-4550L	25W 50K LED WALL PACK PRO SERIES FULL CUTOFF, TYPE 3 DISTRIBUTION, INTERNALLY PAINTED, MOUNTING HEIGHT 8' TO 15' (4550 LUMENS)
UUSES-EESWPC20LEDUNVPS45W50K-8190L	45W 50K LED WALL PACK PRO SERIES FULL CUT OFF, TYPE 3 DISTRIBUTION, INTERNALLY PAINTED, MOUNTING HEIGHT 15' TO 20' (8190 LUMENS)
USES-EESWPC20LEDUNVPS70W50K-12740	70W 50K LED WALL PACK PRO SERIES FULL CUT OFF, TYPE 3 DISTRIBUTION, INTERNALLY PAINTED, MOUNTING HEIGHT 20' TO 30' (12740 LUMENS)

OPTIONS: Emergency Battery Backup - Add EM

120V-277V Photo Cell

40K & 50K Available



Economy Version Also Available
SELECTABLE WATTAGE AND COLOR

SPHERE FULL CUT WALL PACK FIXTURE

ITEM NO.	DESCRIPTION
USES-EESWPC36QC1X25U5KC-4550L	25W 50K LED WALL PACK PRO SERIES SPHERE FIXTURE, TYPE 3 DISTRIBUTION, INTERNALLY PAINTED, MOUNTING HEIGHT 8' TO 15' (4550 LUMENS)
USES-EESWPC36QC1X45U5KC-8190L	45W 50K LED WALL PACK PRO SERIES SPHERE FIXTURE, TYPE 3 DISTRIBUTION, INTERNALLY PAINTED, MOUNTING HEIGHT 15' TO 20' (8190 LUMENS)
USES-EESWPC36QC1X70U5KC-12740L	70W 50K LED WALL PACK PRO SERIES SPHERE FIXTURE, TYPE 3 DISTRIBUTION, INTERNALLY PAINTED, MOUNTING HEIGHT 20' TO 30' (12740 LUMENS)

OPTIONS: Emergency Battery Backup - Add EM

120V-277V Photo Cell

40K & 50K Available



Economy Version Also Available



10 YEAR WARRANTY

For Large Quantities, Call or Email for Quote

US Energy Services, Inc.

Ph: 512.407.8858 • Email Info Requests and Orders to: Sales@us-energyservices.com
www.us-energyservices.com

HALF MOON CUT OFF WALL FIXTURE

ITEM NO.	DESCRIPTION
USES-EESWH15HMWPQF1X25U5KC-4550L	25W 50K LED WALL PACK PRO SERIES HALF MOON FIXTURE, TYPE 3 DISTRIBUTION, INTERNALLY PAINTED, MOUNTING HEIGHT 8' TO 15' (4550 LUMENS)
USES-EESWH15HMWPQF1X45U5KC-8190L	45W 50K LED WALL PACK PRO SERIES HALF MOON FIXTURE, TYPE 3 DISTRIBUTION, INTERNALLY PAINTED, MOUNTING HEIGHT 15' TO 20' (8190 LUMENS)
USES-EESWH15HMWPQF1X70U5KC-12740L	70W 50K LED WALL PACK PRO SERIES HALF MOON FIXTURE, TYPE 3 DISTRIBUTION, INTERNALLY PAINTED, MOUNTING HEIGHT 20' TO 30' (12740 LUMENS)

OPTIONS: Emergency Battery Backup - Add EM 120V-277V Photo Cell 40K & 50K Available



Economy Version Also Available

OPEN FACE WALL PACK FIXTURE

ITEM NO.	DESCRIPTION
USES-EESWP20LEDPSUNV25W-4550L	25W 50K LED WALL PACK PRO SERIES OPEN FACE WALL PACK FIXTURE, TYPE 5 DISTRIBUTION, INTERNALLY PAINTED, MOUNTING HEIGHT 8' TO 15' (4550 LUMENS)
USES-EESWP20LEDPSUNV45W-8190L	45W 50K LED WALL PACK PRO SERIES OPEN FACE WALL PACK FIXTURE, TYPE 5 DISTRIBUTION, INTERNALLY PAINTED, MOUNTING HEIGHT 15' TO 20' (8190 LUMENS)
USES-EESWP20LEDPSUNV70W-12740L	70W 50K LED WALL PACK PRO SERIES OPEN FACE WALL PACK FIXTURE, TYPE 5 DISTRIBUTION, INTERNALLY PAINTED, MOUNTING HEIGHT 20' TO 30' (12740 LUMENS)

OPTIONS: Emergency Battery Backup - Add EM 120-277V Photo Cell 40K & 50K Available



Economy Version Also Available
SELECTABLE WATTAGE AND COLOR



10 YEAR WARRANTY

For Large Quantities, Call or Email for Quote

US Energy Services, Inc.

Ph: 512.407.8858 • Email Info Requests and Orders to: Sales@us-energyservices.com
www.us-energyservices.com

STEALTH FLOOD POLE OR WALL MOUNT FIXTURE

ITEM NO.	DESCRIPTION
USES-EESENV45WLEDLF50KPSUNV****8190L	45W 50K MINI STEALTH LED OPTICAL DISTRIBUTIONS, DIE CAST ALUMINUM HOUSING FRONT FRAME, ANODIZED, TYPE 3 DISTRIBUTION, W/ MOUNTING BRACKETS (8190 LUMENS)
USES-EESENV90WLEDLF50KPSUNV****16380L	90W 50K SMALL STEALTH LED OPTICAL DISTRIBUTIONS, DIE CAST ALUMINUM HOUSING FRONT FRAME, ANODIZED, TYPE 3 DISTRIBUTION, W/ MOUNTING BRACKETS (16380 LUMENS)
USES-EESENV114WLEDLF50KPSUNV****20748L	114W 50K SMALL STEALTH LED OPTICAL DISTRIBUTIONS, DIE CAST ALUMINUM HOUSING FRONT FRAME, ANODIZED, TYPE 3 DISTRIBUTION, W/ MOUNTING BRACKETS (20748 LUMENS)

**** (EHWM) Easy Hang Wall Mount, (PM) Pole Mount or (SFB) Slip Fitter Bracket 40K & 50K Available

Please contact us concerning different poles, mounting options and configurations

Economy Version Also Available



ROUND BACK GROUND FLOOD FIXTURE

ITEM NO.	DESCRIPTION
USES-ENV25WLEDLDRBF50KPSUNV****4550L	25W 50K ROUND BACK FLOOD FIXTURE DIE CAST ALUMINUM HOUSING & HINGED GASKETED LENS FRAME, ADJUSTABLE BRACKET, NICKEL-PLATED STAINLESS STEEL HARDWARE (4550 LUMENS)
USES-ENV45WLEDLDRBF50KPSUNV****8190L	45W 50K ROUND BACK FLOOD FIXTURE DIE CAST ALUMINUM HOUSING & HINGED GASKETED LENS FRAME, ADJUSTABLE BRACKET, NICKEL-PLATED STAINLESS STEEL HARDWARE (8190 LUMENS)
USES-ENV70WLEDLDRBF50KPSUNV****12740L	70W 50K ROUND BACK FLOOD FIXTURE DIE CAST ALUMINUM HOUSING & HINGED GASKETED LENS FRAME, ADJUSTABLE BRACKET, NICKEL-PLATED STAINLESS STEEL HARDWARE (12740 LUMENS)

**** (KM) 3/8" Knuckle Mount or (SFMB) Slip Fitter Mounting Bracket

40K & 50K Available

Economy Version Also Available



10 YEAR WARRANTY

For Large Quantities, Call or Email for Quote

US Energy Services, Inc.

Ph: 512.407.8858 • Email Info Requests and Orders to: Sales@us-energyservices.com
www.us-energyservices.com



US Energy Services, Inc.



**10 YEAR
WARRANTY**

XLLED
The Extra Life LED Solution

THE SIMPLE LED SOLUTION



The Benefits of LED T8 with Ease, Practicality, Flexibility & Sustainability
(No electrician required to change tubes)



Change the LED T8 Tubes any time to different wattage, color temperature or lumens
(Motion Sensors installed to maximize energy savings and LED tube life)

HIGH EFFICIENT EXTERIOR LED FIXTURES



HIGH EFFICIENT EXTERIOR LED WALL PACKS

25 Watts = 4750 Lumens



HIGH EFFICIENT EXTERIOR FLOOD FIXTURES

100 Watts = 19000 Lumens



“Products & Service You Can Trust”

For Large Quantities, Call or Email for Quote

US Energy Services, Inc.

Ph: 512.407.8858 Email InfoRequests and Orders to: Sales@us-energyservices.com
www.us-energyservices.com

OUTDOOR

ECONOMY WALL PACK (NOW SOME WITH SENSOR READY OPTION)



ITEM NO.	DESCRIPTION
USED150SR45W4900LMV50K*	SENSOR READY WALLPACK LED - 45W - 4000K or 5000K - 4900 LUMENS - 100-277V - FINISH: BRONZE - UL/cUL/DLC
USED150SR70W7900LMV50K*	SENSOR READY WALLPACK LED - 70W - 5000K - 7900 LUMENS - 100-277V - FINISH: BRONZE - UL/cUL/DLC
USED200SR90W11200LMV50K*	ECONOMY WALLPACK LED LARGE - 90W - 5000K - 11200 LUMENS - 100-277V - FINISH: BRONZE - UL/cUL/DLC
USED200SR135W15400LMV50K*	ECONOMY WALLPACK LED LARGE - 135W - 5000K - 15400 LUMENS - 100-277V - FINISH: BRONZE - UL/cUL/DLC

Available in 4000K.



MINI LED WALL PACK

ITEM NO.	DESCRIPTION
USED056L17W2000LMV50K*	WALL MOUNT LED - 17W - 2000 Lumen - 120-277V - 5000K - Finish: Bronze - Frosted Lens - cUL/DLC
USED056L17W2000LMV50KPC*	WALL MOUNT LED - 17W - 2000 Lumen - 120-277V - 5000K - PhotoCell - Finish: Bronze - Frosted Lens - cUL/DLC
USED056L25W2700LMV50K*	WALL MOUNT LED - 25W - 2700 Lumen - 120-277V - 5000K - Finish: Bronze - Frosted Lens - cUL/DLC
USED056L25W2700LMV50KPC*	WALL MOUNT LED - 25W - 2700 Lumen - 120-277V - 5000K - PhotoCell - Finish: Bronze - Frosted Lens - cUL/DLC

LED CUTOFF WALL PACK



ITEM NO.	DESCRIPTION
USEDCCSR15045W4900LMV50K*	ECONOMY CUTOFF WALL PACK LED - 45W - 5000K - 4900L 100-277V - BRONZE - DIM Type III beam angle
USEDCCSR15045W4900LMV50K*	SENSOR READY CUTOFF WALL PACK LED - 45W - 5000K - 4900L 100-277V - BRONZE - DIM Type III beam angle
USEDCC200RS90W9700LMV50K*	ECONOMY CUTOFF WALL PACK LED - 90W - 5000K - 9700L 100-277V - BRONZE - DIM Type III beam angle
USEDCCSR135W14500LMV50K*	ECONOMY CUTOFF WALL PACK LED - 135W - 5000K - 14500L 100-277V - BRONZE - DIM Type III beam angle

Available in 4000K.

DECORATIVE CUT-OFF WALL PACK



ITEM NO.	DESCRIPTION
USESM302L35W3456LMV50KBZ	18" x 7,25" x 9.0" / 35W, 3456L / 5000K / BRONZE
USESM302LU5WD35WMV50KBZ	18" x 7,25" x 9.0" / UP, 5W, 480L / DOWN, 35W, 3456L / 5000K / BRONZE
USESM302LU5WD70WMV50KBZ	18" x 7,25" x 9.0" / UP, 5W, 480L / DOWN, 70W, 6735L / 5000K / BRONZE

US Energy Services, Inc.

Ph: 512.407.8858 • Email Info Requests and Orders to: Sales@us-energyservices.com
www.us-energyservices.com

AREA LIGHT - WIDE AREA LIGHTING OR POLE LIGHTS



ITEM NO.	DESCRIPTION
USEPLF12L70W9000LDMV50KBZ	12.4"W x 11.26"L x 3.07"D/ 70W, 9000L/ 0-10V Dim/5000K/ BRONZE
USEPLF12L105W13400LDMV50KBZ	12.4"W x 11.26"L x 3.07"D/ 105W, 13400L/ 0-10V Dim/5000K/ BRONZE
USEPLF15L150W20000LDMV50KBZ	12.4"W x 14.61"L x 3.07"D/ 150W, 20000L/ 0-10V Dim/5000K/ BRONZE
USEPLF15L200W24500LDMV50KBZ	12.4"W x 14.61"L x 3.07"D/ 200W, 24500L/ 0-10V Dim/5000K/ BRONZE
USEPLF23L300W38000LDMV50KBZ	12.4"W x 22.81"L x 3.54"D/ 300W, 38000L/ 0-10V Dim/5000K/ BRONZE
USEPLF23L300W38000L48050KBZ	12.4"W x 22.81"L x 3.54"D/ 300W, 38000L/ 480V/5000K/ BRONZE
USEPLFT415L150W19000LDMV50KBZ	12.4"W x 14.61"L x 3.07"D/ 150W, 19000L/ 0-10V Dim/5000K/ BRONZE
USEPLFT415L200W24500LDMV50KBZ	12.4"W x 14.61"L x 3.07"D/ 200W, 24500L/ 0-10V Dim/5000K/ BRONZE
USEPLFT423L300W39000LDMV50KBZ	12.4"W x 22.81"L x 3.54"D/ 300W, 39000L/ 0-10V Dim/5000K/ BRONZE

Available in 4000K.



ACCESSORIES FOR AREA LIGHT

ITEM NO.	DESCRIPTION
USEPLFSARM	Square pole mntg. arm for PLF Series BRZ 6.97" x 8.578" x 2.55"
USEPLFRARM	Round pole mntg. arm for PLF Series BRZ 6.97" x 8.578" x 2.55"
USEPLFSW	Slip fitter mntg. arm for PLF Series BRZ 9.989" x 3.346
USEPLF15YR	Yoke mount for PLF15 Series BRZ
USEPLF23TR	Trunnion fitter for PLF23 Series BRZ 13.3" x 12.3" x 1.457
USEPLFWARM	Wall mntg. arm for PLF Series BRZ 7.99" x 5.98" x 8.027"

SMALL FLOOD LIGHT



ITEM NO.	DESCRIPTION
USESFL10L50W5562LMV50KBZ	8.9"W x 8.8"H x 1.9"D/ 50W, 5562L/ 5000K/ BRONZE
USESFL10L75W8645LMV50KBZ	12.04"W x 10.6"H x 2.9"D/75W, 8645L/ 5000K/ BRONZE

Consult for different finish options.

MINI FLOOD



ITEM NO.	DESCRIPTION
USELFS46L20W1500LMV40KBZ	LED FLOOD SQ 20W 1500L MV 40K BZ 6"W x 4.75"H x 6"Ext
USELFS46L20W1500LMV40KWH	LED FLOOD SQ 20W 1500L MV 40K WH 6"W x 4.75"H x 6"Ext
USELFS57L30W2700LMV40KBZ	LED FLOOD SQ 30W 2700L MV 40K BZ 7.75"W x 5.75"H x 6.5"Ext
USELFS57L30W2700LMV40KWH	LED FLOOD SQ 30W 2700L MV 40K WH 7.75"W x 5.75"H x 6.5"Ext

LED SMALL ROUND FLOOD



Available in white.

ITEM NO.	DESCRIPTION
USELFS4L8W650LMV40KBZ	8W 650L MV 40K BZ

US Energy Services, Inc.

Ph: 512.407.8858 • Email Info Requests and Orders to: Sales@us-energyservices.com
www.us-energyservices.com

OUTDOOR

REVEAL SMALL ROUND POST TOPS



ITEM NO.	DESCRIPTION
USERPO16L93W7850LDMV50KBK	Reveal Round Open Post Top, 16.125"Dia x 14.875"H, 92.7W / 7887Lm, 5000K, Black Finish
USERPE16L93W6400LDMV50KBK	Reveal Round Enclosed Post Top, 16.125"Dia x 14.875"H, 92.7W / 6391Lm, 5000K, Black Finish



REVEAL LARGE ROUND POST TOPS

ITEM NO.	DESCRIPTION
USERPO26L186W17350LDMV50KBK	Reveal Round Open Post Top, 16.125"Dia x 14.875"H, 186W / 17360Lm, 5000K, Black Finish
USERPE26L186W14500LDMV50KBK	Reveal Round Enclosed Post Top, 26.75"Dia x 19.875"H, 186W / 14521Lm, 5000K, Black Finish



REVEAL SQUARE POST TOPS

ITEM NO.	DESCRIPTION
USESPO21L186W18850LDMV50KBK	Reveal Square Open Post Top, 21.75"Sq x 23.25"H, 186W / 18883Lm, 5000K, Black Finish

Available in 4000K, change "50K" to "40K".



Pole does not include tenon.
Poles can be cut to any length.

Tenon Top Adapter



TEN4
TEN5

STEEL POLES (CONSULT FOR PRICING)

- 12 top holes w/polycarbonate lexan brushings
- Reinforced hand hold cover
- Anchor Bolts and Template Included
- Easily Secured base cover
- Bronze polyester powder-coat finish
- Meets ASTM 500 standard
- Pole cap is included

ITEM NO	DESCRIPTION	SHAFT SIZE	GAGE	BASE PLATE SIZE	BOLT CIRCLE	BOLT SIZE	WEIGHT LBS
UESEPS16411	16 ft. 4 x 4 Square 11 Gauge Pole	16	11	10.5"x1 5"x3/4"	9"-3/16"	3/4" x 30"	126
UESEPS20411	20 ft. 4 X4 Square 11 Gauge Pole	20	11	10.5"x1 5"x3/4"	9"-3/16"	3/4" x 30"	146
UESEPS25411	25 ft. 4 x 4 Square 11 Gauge Pole	25	11	10.5"x10.5"x3/4"	12"-3/4"	3/4" x 30"	180
UESEPS311	30 ft 5 x 5 Square 11 Gauge Pole	30	11	11"x11"x1"	12"-3/4"	1" x 36"	290

2 Light Square Bullhorn



TB180*

4 Light Square Bullhorn



TB490*

Pole Top Cap



TC4
TC5

Pole Base Cover



BC4
BC5

Anchor Bolts



AB3/4X30
AB1X36

Wall Mount Vertical



WMV

*Requires TEN4 or TEN5

US Energy Services, Inc.

Ph: 512.407.8858 • Email Info Requests and Orders to: Sales@us-energyservices.com
www.us-energyservices.com

XLLED

The Benefits of LED with Ease
Practicality and Flexibility

THE SIMPLE LED SOLUTION

XLLED

The most economical, practical and user friendly series of LED fixtures with the energy savings, quality of light, long life and hassle-free maintenance. **XLLED** fixtures are UL Listed with the latest LED T8 Bypass lamps. Fixtures provide over 40% energy savings over comparable fluorescent fixtures, utilizing less expensive fixtures than the

LED Integrated version and have flexibility to change wattage and color temperature any time. Fixture performance will evolve over time with the evolution of the T8 LED lamp technology. **Concerned about maintenance with an LED array and driver fixture?**

XLLED solves that by utilizing LED T8 lamps that fit into the fixture just like a fluorescent lamp **No Electrician Required to Change Drivers or LED Arrays.**



LED System

A complete line of UL Listed, Sustainable LED fixtures with no ballast or driver to fail. Special red sockets to identify fixtures made for LED T8 lamps.



Flexibility and Long Life

Change the LED T8 lamp any time to different wattage, color temperature or lumens.

***10 YEAR WARRANTY WHEN USED WITH MOTION SENSORS**



Premium LED T8 Lamps

US Energy Services uses top quality **XLLED** T8 lamps that are field tested for demanding applications.

RECESSED FIXTURES

LED RECESSED TROFFER



ITEM NO.	DESCRIPTION
USE1X4L232XLN15W40K	1x4 4400 Lumen Troffer w/ 2 x 15W LED T8 4000K Lamps Included
USE2X2L217XLN9W40K	2x2 2800 Lumen Troffer w/ 2 x 9W LED T8 4000K Lamps Included
USE2X2L317XLN9W40K	2x2 4200 Lumen Troffer w/ 3 x 9W Led T8 4000K Lamps Included
USE2X2L417XLN9W40K	2x2 5600 Lumen Troffer w/ 4 x 9W Led T8 4000K Lamps Included
USE2X4L232XLN15W40K	2x4 4400 Lumen Troffer w/ 2 x 15W Led T8 4000K Lamps Included
USE2X4L332XLN15W40K	2x4 6600 Lumen Troffer w/ 3 x 15W Led T8 4000K Lamps Included
USE2X4L432XLN15W40K	2x4 8800 Lumen Troffer w/ 4 x 15W Led T8 4000K Lamps Included

Change 40K to 35K or 50K for different Kelvin. Change Lamp Wattage to 7W on 2FT or 18W on 4FT

EMERGENCY OPTION AVAILABLE

For Large Quantities, Call or Email for Quote

US Energy Services, Inc.

Ph: 512.407.8858 • Email Info Requests and Orders to: Sales@us-energyservices.com
www.us-energyservices.com

PARABOLIC



ITEM NO.	DESCRIPTION
USEPARA8C23212X1LN18W40	1x4 4200 Lumen Parabolic 8C w/2x18W LED T8 4000K Lamps included
USEPARA9C217X1LN15W40	2x2 3400 Lumen Parabolic 9C w/2x15W LED T8 4000K Lamps included
USEPARA9C317X1LN15W40	2x2 5100 Lumen Parabolic 9C w/3x15W LED T8 4000K Lamps included
USEPARA9C417X1LN15W40	2x2 6800 Lumen Parabolic 9C w/4x15W LED T8 4000K Lamps included
USEPARA12C232X1LN18W40	2x4 4200 Lumen Parabolic 12C w/2x18W LED T8 4000K Lamps included
USEPARA18C232X1LN18W40	2x4 4200 Lumen Parabolic 18C w/2x18W LED T8 4000K Lamps included
USEPARA18C332X1LN18W40	2x4 6300 Lumen Parabolic 18C w/3x18W LED T8 4000K Lamps included
USEPARA18C432X1LN18W40	2x4 8400 Lumen Parabolic 18C w/4x18W LED T8 4000K Lamps included
USEPARA32C432X1LN18W40	2x4 8400 Lumen Parabolic 32C w/4x18W LED T8 4000K Lamps included

Change 40 to 35 or 50 for different Kelvin. Change Lamp Wattage to 15W on 2FT or 15W on 4FT

SHALLOW, HIGH EFFICIENT PARABOLIC



ITEM NO.	DESCRIPTION
USEPES9C217X1LN15W40	2x2 3400 Lumen Parabolic 9C w/2x15W LED T8 4000K Lamps Included
USEPES9C317X1LN15W40	2x2 5100 Lumen Parabolic 9C w/3x15W LED T8 4000K Lamps Included
USEPES9C417X1LN15W40	2x2 6800 Lumen Parabolic 9C w/4x15W LED T8 4000K Lamps Included
USEPES12C232X1LN18W40	2x4 4200 Lumen Parabolic 12C w/2x18W LED T8 4000K Lamps Included
USEPES18C232X1LN18W40	2x4 4200 Lumen Parabolic 18C w/2x18W LED T8 4000K Lamps Included
USEPES18C332X1LN18W40	2x4 6300 Lumen Parabolic 18C w/3x18W LED T8 4000K Lamps Included
USEPES18C432X1LN18W40	2x4 8400 Lumen Parabolic 18C w/4x18W LED T8 4000K Lamps Included

Change 40 to 35 or 50 for different Kelvin. Change Lamp Wattage to 15W on 2FT or 15W on 4FT
Change PES to PEW for White Louver

Frame-In-Kits Available for Recessed Fixtures to mount in hard ceilings

- FIK 1x4
- FIK 2x2
- FIK 2x4

For Emergency Option, see page 88.

Consult for Fixtures Wired for LED T8 Lamps with Lamps Sold Separately

For Dimmable Version - Change X1 to JLDMV and LN18W to LN18D

Example: Item No. USE131A432JLDMLN18D40K 0-10V Dimming



For Large Quantities, Call For Quote

CENTER BASKET



ITEM NO.	DESCRIPTION
USEUCPF23212X1LN18W40	1x4 4200 Lumen Center Basket w/2x18W LED T8 4000K Lamps Included
USEUCPF217X1LN15W40	2x2 3400 Lumen Center Basket w/2x15W LED T8 4000K Lamps Included
USEUCPF317X1LN15W40	2x2 5100 Lumen Center Basket w/3x15W LED T8 4000K Lamps Included
USEUCPF232X1LN18W40	2x4 4200 Lumen Center Basket w/2x18W LED T8 4000K Lamps Included
USEUCPF332X1LN18W40	2x4 6300 Lumen Center Basket w/3x18W LED T8 4000K Lamps Included

Change 40 to 35 or 50 for different Kelvin. Change Lamp Wattage to 15W on 2FT or 15W on 4FT
Change PF to LL for Linear Ribbed Lens

DUAL BASKET



ITEM NO.	DESCRIPTION
USEUDPF217X1LN15W40	2x2 3400 Lumen Troffer w/2x15W LED T8 4000K Lamps Included
USEUDPF232X1LN18W40	2x4 4200 Lumen Dual Basket w/2x18W LED T8 4000K Lamps Included

Change 40 to 35 or 50 for different Kelvin. Change Lamp Wattage to 15W on 2FT or 15W on 4FT
Change PF to LL for Linear Ribbed Lens

DEEP CENTER BASKET



ITEM NO.	DESCRIPTION
USERDI217X1LN15W40	2x2 3400 Lumen Center Basket w/2x15W LED T8 4000K Lamps Included
USERDI317X1LN15W40	2x2 5100 Lumen Center Basket w/3x15W LED T8 4000K Lamps Included
USERDI232X1LN18W40	2x4 4200 Lumen Center Basket w/2x18W LED T8 4000K Lamps Included
USERDI332X1LN18W40	2x4 6300 Lumen Center Basket w/3x18W LED T8 4000K Lamps Included

Change 40 to 35 or 50 for different Kelvin. Change Lamp Wattage to 13W on 2FT or 15W on 4FT

For Emergency Option, see page 88.

For Dimmable Version - Change X1 to JLDMV and LN18W to LN18D

Example: Item No. USE131A432JLDMVLN18D40K 0-10V Dimming



For Large Quantities, Call For Quote

4X4 RECESSED LINEAR (FOR T-BAR CEILING)

ITEM NO.	DESCRIPTION
USE44RSF117X1WHLN15W40K	4" x 24" 1700 Lumen Recessed TBAR 1x 15W LED T8 4000K Lamps Included
USE44RSF217X1WHLN15W40K	4" x 24" 3400 Lumen Recessed TBAR 2x 15W LED T8 4000K Lamps Included
USE44RSF132X1WHLN18W40K	4" x 48" 2100 Lumen Recessed TBAR 1x 18W LED T8 4000K Lamps Included
USE44RSF232X1WHLN18W40K	4" x 48" 4200 Lumen Recessed TBAR 2x 18W LED T8 4000K Lamps Included
USE44RSF1328X1WHLN18W40K	4" x 96" 4200 Lumen Recessed TBAR 2x 18W LED T8 4000K Lamps Included
USE44RSF2328X1WHLN18W40K	4" x 96" 8400 Lumen Recessed TBAR 4x 18W LED T8 4000K Lamps Included

Change 40 to 35 or 50 for different Kelvin. Change Lamp Wattage to 15W on 2FT or 15W on 4FT Change SF (Snap Fit Frosted Lens) to MW for Matte White Regressed Lens
Change USE44R to USE44RF for Recessed Flanged or USE44RRXX for Recessed Flangeless for XX" sheetrock depth. For Baffled Louver, change MW to BL



Special red sockets to identify fixtures made for LED T8 lamps.

6X6 RECESSED LINEAR (FOR T-BAR CEILING)

ITEM NO.	DESCRIPTION
USE66RMW117X1WHLN15W40K	6" x 26" 1700 Lumen Recessed TBAR 1x 15W LED T8 4000K Lamps Included
USE66RMW217X1WHLN15W40K	6" x 26" 3400 Lumen Recessed TBAR 2x 15W LED T8 4000K Lamps Included
USE66RMW132X1WHLN18W40K	6" x 48" 2100 Lumen Recessed TBAR 1x 18W LED T8 4000K Lamps Included
USE66RMW232X1WHLN18W40K	6" x 48" 4200 Lumen Recessed TBAR 2x 18W LED T8 4000K Lamps Included
USE66RMW1328X1WHLN18W40K	6" x 96" 4200 Lumen Recessed TBAR 2x 18W LED T8 4000K Lamps Included
USE66RMW2328X1WHLN18W40K	6" x 96" 8400 Lumen Recessed TBAR 4x 18W LED T8 4000K Lamps Included

Change 40 to 35 or 50 for different Kelvin. Change Lamp Wattage to 15W on 2FT or 15W on 4FT Change 66R to 66RF for Recessed Flanged or USE66RRXX for Recessed Flangeless for XX" sheetrock depth. For Baffled Louver, change MW to BL



2.5 RECESSED LINEAR (FLANGED FOR HARD CEILINGS)

ITEM NO.	DESCRIPTION
USESES25RFSF117X1WHLN15W40K	4"x24" 1700 Lumen Recessed 2.5" Flanged 1x15W LED T8 4000K Lamps Included
USESES25RFSF132X1WHLN18W40K	4"x48" 2100 Lumen Recessed 2.5" Flanged 1x18W LED T8 4000K Lamps Included
USESES25RFSF1328X1WHLN18W40K	4"x96" 4200 Lumen Recessed 2.5" Flanged 2x18W LED T8 4000K Lamps Included

Change 40 to 35 or 50 for different Kelvin. Change Lamp Wattage to 15W on 2FT or 15W on 4FT Change USESES25RFSF to USE44R for Recessed TBAR or USESES25RRXX for Recessed Flangeless for XX" sheetrock depth.



Shown with Flange
USESES25RFSF

For Dimmable Version - Change X1 to JLDMV and LN18W to LN18D

Example: Item No. USE131A432JLDMLN18D40K 0-10V Dimming



For Large Quantities, Call For Quote



LOUVER BLADE LINEAR PENDANT

ITEM NO.	DESCRIPTION
USEPLIN48LUF48W4000LDMV40KWH	48" LIN 48W UP ONLY 4000 Lumen 4000K Tunable up to 60W w/4ft. cable kit (Change wattage in part number)
USEPLIN96LUP72W6000LDMV40KWH	96" LIN 72W UP ONLY 6000 Lumen 4000K Tunable up to 144W w/4ft. cable kit (Change wattage in part number)

Change 40K to 35K or 50K for different Kelvin. Available in various wattages and lumens.
Change WH to BK (Black), RD (Red), IR (Iron), SL (Silver) or BR (Bronze) 48" and 96"

Add SD - Solid
Add MW - White Lens
Add LV - Louver

4X4 LINEAR PENDANT



ITEM NO.	DESCRIPTION
USELPS44117XLWHLN9W40-HC301WH	4" x 24" 1400 Lumen Pendant w/ Cable Kit 1 x 9W LED T8 4000K Lamps Included
USELPS44217XLWHLN9W40-HC301WH	4" x 24" 2800 Lumen Pendant w/ Cable Kit 2 x 9W LED T8 4000K Lamps Included
USELPS44132XLWHLN15W40-HC301WH	4" x 48" 2200 Lumen Pendant w/ Cable Kit 1 x 15W LED T8 4000K Lamps Included
USELPS44232XLWHLN15W40-HC301WH	4" x 48" 4400 Lumen Pendant w/ Cable Kit 2 x 15W LED T8 4000K Lamps Included
USELPS441328XLWHLN15W40-HC301WH	4" x 96" 4400 Lumen Pendant w/ Cable Kit 2 x 15W LED T8 4000K Lamps Included
USELPS442328XLWHLN15W40-HC301WH	4" x 96" 8800 Lumen Pendant w/Cable Kit 4 x 15W LED T8 4000K Lamps Included

Change 40K to 35K or 50K for different Kelvin. Change Lamp Wattage to 7W on 2ft or 18W on 4ft
Change SF (Snap Fit Frosted Lens) to MW for Matte White Regressed Lens
Change HC301WH to HC302WH for 10" Cable Kit
Change WH to BK (Black), IR (Iron), SL (Silver) or BR (Bronze) 48" and 96"
For surface mount, remove HC301WH

6X6 LINEAR PENDANT



ITEM NO.	DESCRIPTION
USELPS44117XLWHLN9W40-HC301WH	4" x 24" 1400 Lumen Pendant w/ Cable Kit 1 x 9W LED T8 4000K Lamps Included
USELPS44217XLWHLN9W40-HC301WH	4" x 24" 2800 Lumen Pendant w/ Cable Kit 2 x 9W LED T8 4000K Lamps Included
USELPS44132XLWHLN15W40-HC301WH	4" x 48" 2200 Lumen Pendant w/ Cable Kit 1 x 15W LED T8 4000K Lamps Included
USELPS44232XLWHLN15W40-HC301WH	4" x 48" 4400 Lumen Pendant w/ Cable Kit 2 x 15W LED T8 4000K Lamps Included
USELPS441328XLWHLN15W40-HC301WH	4" x 96" 4400 Lumen Pendant w/ Cable Kit 2 x 15W LED T8 4000K Lamps Included
USELPS442328XLWHLN15W40-HC301WH	4" x 96" 8800 Lumen Pendant w/ Cable Kit 4 x 15W LED T8 4000K Lamps Included

Change 40K to 35K or 50K for different Kelvin. Change Lamp Wattage to 7W on 2ft or 18W on 4ft
Change HC301WH to HC302WH for 10" Cable Kit Change WH to BK (Black), IR (Iron), SL (Silver) or BR (Bronze) 48" and 96" For surface mount, remove HC301WH For Baffled Louve , change MW to BL

EMERGENCY OPTION AVAILABLE

For Dimmable Version - Change XL to JLDLV and LN15W to LN15D

Example: Item No. USELPS442328JLDLVWHLN18D40-HC301WH **0-10VDimming**



For Large Quantities, Call or Email for Quote



LED T8 PENDANT (SUSPENDED ONLY - COMES W/ PENDANT)

ITEM NO.	DESCRIPTION
USELP132XLCHLN15W40K	48" Linear Pendant 2200 Lumens 1 x 15W LED T8 Chrome
USELP132XLWHLN15W40K	48" Linear Pendant 2200 Lumens 1 x 15W LED T8 White

Comes with 5ft. Cable Kit. Also Available in 3500K and 5000K



Shown in Black (BK)

LOUVERED 8" DECORATIVE LINEAR PENDANT

ITEM NO.	DESCRIPTION
USELDLV48232XLWHLN15W40K-HC301WH	48" LVS WHITE 4400 Lumen 2 x 15W LED T8 4000K Lamps included W/ 5 FT Cable Kit
USELDLV96432XLWHLN15W40K-HC301WH	96" LVS WHITE 8800 Lumen 4 x 15W LED T8 4000K Lamps included W/ 5 FT Cable Kit

Change 40K to 35K or 50K for different Kelvin. Change Lamp Wattage to 18W on 4FT
Change WH to BK (Black), IR (Iron), SL (Silver) or BR (Bronze) 48" and 96"



LOUVERED 6" DECORATIVE LINEAR PENDANT

ITEM NO.	DESCRIPTION
USELDLV6232XLWHLN15W40-HC301WH	48" LVS WHITE 4400 Lumen 2 x 15W LED T8 4000K Lamps included W/ 5 FT Cable Kit
USELDLV62328XLWHLN15W40-HC401WH	96" LVS WHITE 8800 Lumen 4 x 15W LED T8 4000K Lamps included W/ 5 FT Cable Kit

Change 40K to 35K or 50K for different Kelvin. Change Lamp Wattage to 18W on 4FT Change WH to BK (Black), IR (Iron), SL (Silver) or BR (Bronze) 48" and 96"



Detail View

1 LIGHT 2.5" ENCLOSED PENDANT AVAILABLE WITH T8 & LED ARRAY

ITEM NO.	DESCRIPTION
USEENST25FR132XLLN15W40-HC301WH	2.5"x 48" Pendant or Surface Linear 2200 Lumen 1 x 15W LED T8 4000K Lamps included
USEENST25FR1328XLLN15W40-HC301WH	2.5"x 96" Pendant or Surface Linear 4400 Lumen 2 x 15W LED T8 4000K Lamps included

Change 40K to 35K or 50K for different Kelvin. Change Lamp Wattage to 18W on 4FT
Change WH to BK (Black), IR (Iron), SL (Silver) or BR (Bronze) 48" and 96"
Specify Wattage for LED Array Fixtures

For Dimmable Version - Change XL to JLDMMV and LN15W to LN15D
Add 1 Light Fixture; Add 2 Light Fixture
Add 3 Light Fixture; Add 4 Light Fixture
Example: Item No. USEENST25FR1328JLDMMVLN15D40-HC301WH **0-10VDimming**



For Large Quantities, Call or Email for Quote

SURFACE TROFFER



ITEM NO.	DESCRIPTION
USE153A23212X1LN18W40	1x4 4200 Lumen Troffer w/2x18W LED T8 4000K Lamps Included
USE153A217X1LN18W40	2x2 3400 Lumen Troffer w/2x15W LED T8 4000K Lamps Included
USE153A317X1LN18W40	2x2 5100 Lumen Troffer w/3x15W LED T8 4000K Lamps Included
USE153A417X1LN18W40	2x2 6800 Lumen Troffer w/4x15W LED T8 4000K Lamps Included
USE153A232X1LN18W40	2x4 4200 Lumen Troffer w/2x18W LED T8 4000K Lamps Included
USE153A332X1LN18W40	2x4 6300 Lumen Troffer w/3x18W LED T8 4000K Lamps Included
USE153A432X1LN18W40	2x4 8400 Lumen Troffer w/4x18W LED T8 4000K Lamps Included

Change 40 to 35 or 50 for different Kelvin. Change Lamp Wattage to 15W on 2FT or 15W on 4FT
For Frosted Lens change A to FR

SURFACE PARABOLIC



Special red sockets to identify fixtures made for LED T8 lamps.

ITEM NO.	DESCRIPTION
USESHPARA8C23212X1LN18W40	1x4 4200 Lumen Parabolic 8C w/2x18W LED T8 4000K Lamps Included
USESHPARA9C217X1LN15W40	2x2 3400 Lumen Parabolic 9C w/2x15W LED T8 4000K Lamps Included
USESHPARA9C317X1LN15W40	2x2 5100 Lumen Parabolic 9C w/3x15W LED T8 4000K Lamps Included
USESHPARA9C417X1LN15W40	2x2 6800 Lumen Parabolic 9C w/4x15W LED T8 4000K Lamps Included
USESHPARA12C232X1LN18W40	2x4 4200 Lumen Parabolic 12C w/2x18W LED T8 4000K Lamps Included
USESHPARA18C232X1LN18W40	2x4 4200 Lumen Parabolic 18C w/2x18W LED T8 4000K Lamps Included
USESHPARA18C332X1LN18W40	2x4 6300 Lumen Parabolic 18C w/3x18W LED T8 4000K Lamps Included
USESHPARA18C432X1LN18W40	2x4 8400 Lumen Parabolic 18C w/4x18W LED T8 4000K Lamps Included
USESHPARA32C432X1LN18W40	2x4 8400 Lumen Parabolic 32C w/4x18W LED T8 4000K Lamps Included

Change 40 to 35 or 50 for different Kelvin. Change Lamp Wattage to 15W on 2FT or 15W on 4FT

For Emergency Option, see page 88.

For Dimmable Version - Change X1 to JLDMV and LN18W to LN18D

Example: Item No. USE131A432JLDMVLN18D40K 0-10V Dimming



For Large Quantities, Call For Quote

SURFACE HIGH EFFICIENT PARABOLIC



(Surface Mount has shroud)

ITEM NO.	DESCRIPTION
UESHPES9C217X1LN15W40	2x2 3400 Lumen Parabolic 9C w/2x15W LED T8 4000K Lamps Included
UESHPES9C317X1LN15W40	2x2 5100 Lumen Parabolic 9C w/3x15W LED T8 4000K Lamps Included
UESHPES9C417X1LN15W40	2x2 6800 Lumen Parabolic 9C w/4x15W LED T8 4000K Lamps Included
UESHPES12C232X1LN18W40	2x4 4200 Lumen Parabolic 12C w/2x18W LED T8 4000K Lamps Included
UESHPES18C232X1LN18W40	2x4 4200 Lumen Parabolic 18C w/2x18W LED T8 4000K Lamps Included
UESHPES18C332X1LN18W40	2x4 6300 Lumen Parabolic 18C w/3x18W LED T8 4000K Lamps Included
UESHPES18C432X1LN18W40	2x4 8400 Lumen Parabolic 18C w/4x18W LED T8 4000K Lamps Included

Change 40 to 35 or 50 for different Kelvin. Change Lamp Wattage to 15W on 2FT or 15W on 4FT
Change PES to PEW for White Louver

SURFACE CENTER BASKET



ITEM NO.	DESCRIPTION
UESHUCPF23212X1LN18W40	1x4 4200 Lumen Center Basket w/2x18W LED T8 4000K Lamps Included
UESHUCPF217X1LN18W40	2x2 3400 Lumen Center Basket w/2x15W LED T8 4000K Lamps Included
UESHUCPF317X1LN18W40	2x2 5100 Lumen Center Basket w/3x15W LED T8 4000K Lamps Included
UESHUCPF232X1LN18W40	2x4 4200 Lumen Center Basket w/2x18W LED T8 4000K Lamps Included
UESHUCPF332X1LN18W40	2x4 6300 Lumen Center Basket w/3x18W LED T8 4000K Lamps Included

Change 40 to 35 or 50 for different Kelvin. Change Lamp Wattage to 15W on 2FT or 15W on 4FT
Change PF to LL for Linear Ribbed Lens

Consult for Wired for LED T8 Lamps with Lamps Sold Separately

SURFACE DUAL BASKET



ITEM NO.	DESCRIPTION
UESHUDPF217X1LN15W40	2x2 3400 Lumen Dual Basket w/2x15W LED T8 4000K Lamps Included
UESHUDPF232X1LN18W40	2x4 4200 Lumen Dual Basket w/2x18W LED T8 4000K Lamps Included

Change 40 to 35 or 50 for different Kelvin. Change Lamp Wattage to 15W on 2FT or 15W on 4FT
Change PF to LL for Linear Ribbed Lens

For Dimmable Version - Change X1 to JLDMV and LN18W to LN18D

Example: Item No. USE131A432JLDMVLN18D40K 0-10V Dimming



For Emergency Option, see page 88.

For Large Quantities, Call For Quote

ECLIPSE



ITEM NO.	DESCRIPTION
USEECLMW217X1WHLN15W40K (TO, BM, IM, SI, WM)	9"x24" 3400 Lumen w/2x15W LED T8 4000K Lamps Included
USEECLMW232X1WHLN18W40K (TO, BM, IM, SI, WM)	9"x48" 4200 Lumen w/2x18W LED T8 4000K Lamps Included
USEECLMW417X1WHLN15W40K (TO, BM, IM, SI, WM)	17"x24" 6800 Lumen w/4x15W LED T8 4000K Lamps Included
USEECLMW432X1WHLN18W40K (TO, BM, IM, SI, WM)	17"x48" 8400 Lumen w/4x18W LED T8 4000K Lamps Included

Change 40 to 35 or 50 for different Kelvin. Change Lamp Wattage to 15W on 2FT or 15W on 4FT

PUF SURFACE LINEAR



ITEM NO.	DESCRIPTION
USEPUF23211X1LN18W40K	11x48 inches 4200 Lumen w/2x18W LED T8 4000K Lamps Included
USEPUF41717X1LN15W40K	17x24 inches 6800 Lumen w/4x15W LED T8 4000K Lamps Included
USEPUF43217X1LN18W40K	17x48 inches 8400 Lumen w/4x18W LED T8 4000K Lamps Included

Change 40 to 35 or 50 for different Kelvin. Change Lamp Wattage to 15W on 4FT.

CROWN



ITEM NO.	DESCRIPTION
USECRWNMW217X1WHLN15W40K	9x24 inches 3400 Lumen w/2x15W LED T8 4000K Lamps Included
USECRWNMW417X1WHLN15W40K	17x24 inches 6800 Lumen w/4x15W LED T8 4000K Lamps Included
USECRWNMW232X1WHLN18W40K	9x48 inches 4200 Lumen w/2x18W LED T8 4000K Lamps Included
USECRWNMW432X1WHLN18W40K	17x48 inches 8400 Lumen w/4x18W LED T8 4000K Lamps Included

Change 40 to 35 or 50 for different Kelvin. Change Lamp Wattage to 15W on 2FT or 15W on 4FT
Consult for Alternate Wood Finishes

For Emergency Option, see page 88.

For Dimmable Version - Change X1 to JLDMMV and LN18W to LN18D

Example: Item No. USE131A432JLDMMVLN18D40K 0-10V Dimming



For Large Quantities, Call For Quote



Ideal for Residential Use

Change 40 to 35 or 50 for different Kelvin. Change Lamp Wattage to 15W on 2FT or 15W on 4FT

WRAPAROUND 7"

ITEM NO.	DESCRIPTION
USE207A217X1LN15W40	7" x 24" 3400 Lumen 2 Light Wraparound w/2x15W LED T8 4000K Lamps Included
USE207A232X1LN18W40	7" x 48" 4200 Lumen 2 Light Wraparound w/2x18W LED T8 4000K Lamps Included
USE207A332X1LN18W40	13" x 48" 6300 Lumen 3 Light Wraparound w/3x18W LED T8 4000K Lamps Included
USE207A432X1LN18W40	13" x 48" 8400 Lumen 4 Light Wraparound w/4x18W LED T8 4000K Lamps Included



WRAPAROUND 9"

ITEM NO.	DESCRIPTION
USE209A232AX1LN18W40	9" x 48" 4200 Lumen 2 Light Wraparound w/2x18W LED T8 4000K Lamps Included

Change 40 to 35 or 50 for different Kelvin. Change Lamp Wattage to 15W on 2FT or 15W on 4FT



Change 40 to 35 or 50 for different Kelvin. Change Lamp Wattage to 15W on 2FT or 15W on 4FT

WRAPAROUND SPECIFICATION GRADE

ITEM NO.	DESCRIPTION
USE200A217X1LN15W40	11" x 24" 3400 Lumen 2 Light Wraparound w/2x15W LED T8 4000K Lamps Included
USE200A232X1LN18W40	11" x 48" 4200 Lumen 2 Light Wraparound w/2x18W LED T8 4000K Lamps Included
USE200A2328X1LN18W40	11" x 96" 8400 Lumen 4 Light Wraparound w/4x18W LED T8 4000K Lamps Included
USE200A432X1LN18W40	16" x 48" 8400 Lumen 4 Light Wraparound w/4x18W LED T8 4000K Lamps Included
USE200A4328X1LN18W40	16" x 96" 16800 Lumen 8 Light Wraparound w/8x18W LED T8 4000K Lamps Included



Change 40 to 35 or 50 for different Kelvin. Change Lamp Wattage to 15W on 2FT or 15W on 4FT

NARROW WRAPAROUND

ITEM NO.	DESCRIPTION
USE201A117X1LN18W40	5" x 24" 1700 Lumen 1 Light Wraparound w/1x15W LED T8 4000K Lamps Included
USE201A132X1LN18W40	5" x 48" 2100 Lumen 1 Light Wraparound w/1x18W LED T8 4000K Lamps Included



Change 40 to 35 or 50 for different Kelvin. Change Lamp Wattage to 15W on 2FT or 15W on 4FT

CORRIDOR LINEAR

ITEM NO.	DESCRIPTION
USE159A117X1LN18W40	5" x 24" 1700 Lumen 1 Light Wraparound w/1x15W LED T8 4000K Lamps Included
USE159A132X1LN18W40	5" x 48" 2100 Lumen 1 Light Wraparound w/1x18W LED T8 4000K Lamps Included
USE159A1328X1LN18W40	5" x 96" 4200 Lumen 1 Light Wraparound w/2x18W LED T8 4000K Lamps Included

For Dimmable Version - Change X1 to JLDMV and LN18W to LN18D

Example: Item No. USE131A432JLDMVLN18D40K 0-10V Dimming



Consult for Fixtures Wired for LED T8 Lamps with Lamps Sold Separately

For Emergency Option, see page 88.

For Large Quantities, Call For Quote

BEST SELLER



2, 3, 4 LIGHT STRIP 4.25" & 5" CHANNEL STRIPS

ITEM NO.	DESCRIPTION
USE2ST217XLN9W40K	2FT Strip 2800 Lumen 2 x 9W LED T8 4000K Lamps Included
USE2ST317XLN9W40K	2FT Strip 4200 Lumen 3 x 9W LED T8 4000K Lamps Included
USE4ST232XLN18.5W40K	4FT Strip 5200 Lumen 2 x 18.5W LED T8 4000K Lamps Included
USE4ST332XLN18.5W40K	4FT Strip 7800 Lumen 3 x 18.5W LED T8 4000K Lamps Included
USE8ST2328XLN18.5W40K	8FT Tandum Strip 10400 Lumen 4 x 18.5W LED T8 4000K Lamps Included

Change 40K to 35K or 50K for different Kelvin. Change Lamp Wattage to 9W on 2FT or 15W on 4FT

ADD MS - MOTION SENSOR & GET A 10 YEAR WARRANTY ON XLLED LAMPS

1 LIGHT STRIP 2.75"



ITEM NO.	DESCRIPTION
USE2ST117XLN9W40K	2FT Strip 1400 Lumen 1 x 9W LED T8 4000K Lamp Included
USE4ST132XLN15W40K	4FT Strip 2200 Lumen 1 x 15W LED T8 4000K Lamp Included
USE8ST2328XLN15W40K	8FT Tandum Strip 4400 Lumen 2 x 15W LED T8 4200K Lamp Included

Change 40K to 35K or 50K for different Kelvin. Change Lamp Wattage to 7W on 2FT or 18W on 4FT

MINI STRIP (1.6) 1 LIGHT



ITEM NO.	DESCRIPTION
USE2MINST117XLN9W40K	2FT Strip 1400 Lumen 1 x 9W LED T8 4000K Lamp Included
USE4MINST132XLN15W40K	4FT Strip 2200 Lumen 1 x 15W LED T8 4000K Lamp Included

Change 40K to 35K or 50K for different Kelvin. Change Lamp Wattage to 7W on 2FT or 18W on 4FT



For Large Quantities, Call or Email for Quote



SIDE MOUNT STRIP

ITEM NO.	DESCRIPTION
USESM117X1LI15W40	2ft. Strip 1700 Lumen 1x15W LED T8 4000K Lamps Included
USESM217X1LI18W40	2ft. Strip 3400 Lumen 2x15W LED T8 4000K Lamps Included
USESM132X1LI18W40	4ft. Strip 2100 Lumen 1x18W LED T8 4000K Lamps Included
USESM232X1LI18W40	4ft. Strip 4200 Lumen 2x18W LED T8 4000K Lamps Included

Change 40 to 35 or 50 for different Kelvin. Change Lamp Wattage to 15W on 2FT or 15W on 4FT

INDUSTRIAL



ITEM NO.	DESCRIPTION
USEIND232W30X1LI18W40	4ft. Industrial 4200 Lumen 2x18W LED T8 4000K Lamps Included
USEIND332W30X1LI18W40	4ft. Industrial 6300 Lumen 3x18W LED T8 4000K Lamps Included
USEIND2328W30X1LI18W40	8ft. Tandem Industrial 8400 Lumen 4x18W LED T8 4000K Lamps Included
USEIND3328W30X1LI18W40	8ft. Tandem Industrial 12600 Lumen 6x18W LED T8 4000K Lamps Included

Change 40 to 35 for different Kelvin. Change Lamp Wattage to 15W on 2FT or 15W on 4FT

Order USEIND48WG for Wire Guard

RECESSED STRIP ITB



ITEM NO.	DESCRIPTION
USEITB132X1LI18W40	4ft. Industrial 2100 Lumen 1x18W LED T8 4000K Lamps Included
USEITB232X1LI18W40	4ft. Recessed Linear 4200 Lumen 2x18W LED T8 4000K Lamps Included
USEITB1328X1LI18W40	8ft. Tandem Recessed Linear 4200 Lumen 2x18W LED T8 4000K Lamps Included
USEITB2328X1LI18W40	8ft. Tandem Recessed Linear 8400 Lumen 4x18W LED T8 4000K Lamps Included

Change 40 to 35 or 50 for different Kelvin. Change Lamp Wattage to 15W on 2FT or 15W on 4FT

For Emergency Option, see page 88.

For Dimmable Version - Change X1 to JLDMV and LN18W to LN18D

Example: Item No. USE131A432JLDMLN18D40K 0-10V Dimming



For Large Quantities, Call For Quote

US Energy Services, Inc.

PREMIERE HIGH BAY



ITEM NO.	DESCRIPTION
USEHBC432M23X1LN18W50	High Bay 48 inch 8400 Lumens w/4x18W LED T8 5000K Lamps Included
USEHBC632M23X1LN18W50	High Bay 48 inch 12600 Lumens w/6x18W LED T8 5000K Lamps Included
USEHBC832M23X1LN18W50	High Bay 48 Inches 16800 Lumens w/8x18W LED T8 5000K Lamps Included
USEHBC1032M23X1LN18W50	High Bay 48 Inches 21000 Lumens w/10x18W LED T8 5000K Lamps Included
USEHBC1232M23X1LN18W50	High Bay 48 Inches 25200 Lumens w/12x18W LED T8 5000K Lamps Included

Change 50 to 35 or 40 for different Kelvin. Change Lamp Wattage to 15W on 4FT.

INDUSTRIALIZED GALVANIZED HIGH BAY



ITEM NO.	DESCRIPTION
USEHBG432M23X1LN18W50	High Bay 48 Inches 8400 Lumens w/4x18W LED T8 5000K Lamps Included
USEHBG632M23X1LN18W50	High Bay 48 Inches 12600 Lumens w/6x18W LED T8 5000K Lamps Included
USEHBG832M23X1LN18W50	High Bay 48 Inches 16800 Lumens w/8x18W LED T8 5000K Lamps Included
USEHBG1032M23X1LN18W50	High Bay 48 Inches 21000 Lumens w/10x18W LED T8 5000K Lamps Included
USEHBG1232M23X1LN18W50	High Bay 48 Inches 25200 Lumens w/12x18W LED T8 5000K Lamps Included

Change 50 to 35 or 40 for different Kelvin. Change Lamp Wattage to 15W on 4FT

USEH6L SERIES



ITEM NO.	DESCRIPTION
USEH6L4328M23X1LN18W50	High Bay 96 Inches Tandem 16800 Lumens w/8x18W LED T8 5000K Lamps Included
USEH6L432M23X1LN18W50	High Bay 48 Inches Tandem 8400 Lumens w/4x18W LED T8 5000K Lamps Included
USEH6L6328M23X1LN18W50	High Bay 96 Inches Tandem 21000 Lumens w/10x18W LED T8 5000K Lamps Included
USEH6L632M23X1LN18W50	High Bay 48 Inches Tandem 12600 Lumens w/6x18W LED T8 5000K Lamps Included

Change 50 to 35 or 40 for different Kelvin. Change Lamp Wattage to 15W on 4FT

For Emergency Option, see page 88.

For Dimmable Version - Change X1 to JLDMV and LN18W to LN18D

Example: Item No. USE131A432JLDMVLN18D40K 0-10V Dimming



For Large Quantities, Call For Quote



H2L SERIES

ITEM NO.	DESCRIPTION
USEH2L132M23X1LN18W50	High Bay 48 Inches 2100 Lumens w/1x18W LED T8 5000K Lamps Included
USEH2L232M23X1LN18W50	High Bay 48 Inches 4200 Lumens w/2x18W LED T8 5000K Lamps Included

Change 50 to 35 or 40 for different Kelvin. Change Lamp Wattage to 15W on 4FT.

BAFFLED HIGH BAY

ITEM NO.	DESCRIPTION
USEFHBL232X1LN18W50	Linear Louvered 48 Inches 4200 Lumens w/2x18W LED T8 5000K Lamps Included
USEFHBL332X1LN18W50	Linear Louvered 48 Inches 6300 Lumens w/3x18W LED T8 5000K Lamps Included
USEFHBL432X1LN18W50	Linear Louvered 48 Inches 8400 Lumens w/4x18W LED T8 5000K Lamps Included
USEFHBL2328X1LN18W50	Linear Baffled Louver 96 Inches Tandem 8400 Lumens w/4x18W LED T8 5000K Lamps Included
USEFHBL3328X1LN18W50	Linear Baffled Louver 96 Inches Tandem 12600 Lumens w/6x18W LED T8 5000K Lamps Included
USEFHBL4328X1LN18W50	Linear Baffled Louver 96 Inches Tandem 16800 Lumens w/8x18W LED T8 5000K Lamps Included

Change 50 to 35 or 40 for different Kelvin. Change Lamp Wattage to 15W on 4FT.



Special red sockets to identify fixtures made for LED T8 lamps.

VAPOR TIGHT HIGH BAY WET LOCATION

(IDEAL FOR COLD STORAGE AND WASH DOWN) IP65, IP66 IP67, NEMA 4X

ITEM NO.	DESCRIPTION
USECITA432X1LN18W40	14.61" x 51.91" Enclosure w/Clear Lens 8400 Lumen 4x18W LED T8 4000K Lamps Included
USECITA632X1LN18W40	14.61" x 51.91" Enclosure w/Clear Lens 12600 Lumen 6x18W LED T8 4000K Lamps Included

For Emergency add EM. See specification sheet for mounting options and accessories. CL i Clear Acrylic Lens, change to FR for Frosted Acrylic Lens. For Polycarbonate Versions add PC after CL or FR. Available in 3000K, 3500K and 4000K.

For Emergency Option, see page 88.

For Dimmable Version - Change X1 to JLDMMV and LN18W to LN18D

Example: Item No. USE131A432JLDMMVLN18D40K 0-10V Dimming



For Large Quantities, Call For Quote



UL Listed kit to bypass Fluorescent Ballast w/LED tubes.

Add "8" after USERLK for tandem version

To wire for Troffer Retrofit, add "TR" after "USERLK".

Retrofit LED T8 Lamp Kit (Convert Existing Fluorescent Fixtures to LED)

ITEM NO.	DESCRIPTION
USERLK1X1WR	Retrofit Lamp Kit Prewired Unshunted Sockets For 1 LED T8 Lamp Includes Companion Sockets
USERLK2X1WR	Retrofit Lamp Kit Prewired Unshunted Sockets For 2 LED T8 Lamp Includes Companion Sockets
USERLK3X1WR	Retrofit Lamp Kit Prewired Unshunted Sockets For 3 LED T8 Lamp Includes Companion Sockets
USERLK4X1WR	Retrofit Lamp Kit Prewired Unshunted Sockets For 4 LED T8 Lamp Includes Companion Sockets
USERLK1X1WRLI18W40	Retrofit Lamp Kit Prewired Unshunted Sockets For 1 LED T8 Lamp Included Plus Companion Sockets
USERLK2X1WRLI18W40	Retrofit Lamp Kit Prewired Unshunted Sockets For 2 LED T8 Lamp Included Plus Companion Sockets
USERLK3X1WRLI18W40	Retrofit Lamp Kit Prewired Unshunted Sockets For 3 LED T8 Lamp Included Plus Companion Sockets
USERLK4X1WRLI18W40	Retrofit Lamp Kit Prewired Unshunted Sockets For 4 LED T8 Lamp Included Plus Companion Sockets

Consult for Dimmable LED Lamps Retrofit Kit



4 Ft. Wiring Harness

(This kit will change a two lamp fluorescent to a dimmable two lamp with LED T8 lamps)



LED Dimming Kit for 8 FT. Tandem 1 Light Strip
(Shown w/Optional Wiring Harness for Continuous Run)

RETROFIT REFLECTOR KIT FOR PARABOLICS/TROFFERS



To wire for Troffer Retrofit.

ITEM NO.	DESCRIPTION
USE22C2M20BL11X1LI15W40	2x2 Retrofit Kit 4200 Lumen Mirrored Reflecto Includes 2x15W 4000K Lamps
USE22C2W10BL11X1LI15W40	2x2 Retrofit Kit 4200 Lumen Enhanced White Reflecto Includes 2x15W 4000K Lamps
USE22C3M20BL11X1LI15W40	2x2 Retrofit Kit 6300 Lumen Mirrored Reflecto Includes 3x15W 4000K Lamps
USE22C3W10BL11X1LI15W40	2x2 Retrofit Kit 6300 Lumen Enhanced White Reflecto Includes 3x15W 4000K Lamps
USE24C2M20BL11X1LI18W40	2x4 Retrofit Kit 4200 Lumen Mirrored Reflecto Includes 2x18W 4000K Lamps
USE24C2W10BL11X1LI18W40	2x4 Retrofit Kit 4200 Lumen Enhanced White Reflecto Includes 2x18W 4000K Lamps
USE24C3M20BL11X1LI18W40	2x4 Retrofit Kit 6300 Lumen Mirrored Reflecto Includes 3x18W 4000K Lamps
USE24C3W10BL11X1LI18W40	2x4 Retrofit Kit 6300 Lumen Enhanced White Reflecto Includes 3x18W 4000K Lamps

Change 40 to 35 or 50 for different Kelvin. Change Lamp Wattage to 15W on 2FT or 15W on 4FT.

For Dimmable Version - Change X1 to JLDMV and LN18W to LN18D

Example: Item No. USE131A432JLDMVLN18D40K 0-10V Dimming



For Large Quantities, Call For Quote

US Energy Services, Inc.

BALLAST COVER REFIT KIT (Ideal to change 8ft Lamps to 4ft Tandem)



ITEM NO.	DESCRIPTION
USE4RB421T8L11X1LI18W40	4.25" Strip Retrofit Kit 48 In. 2100 Lumen Include 1x18W 4000K Lamp
USE4RB422T8L11X1LI18W40	4.25" Strip Retrofit Kit 48 In. 4200 Lumen Include 2x18W 4000K Lamp
USE4RB501T8L11X1LI18W40	5" Strip Retrofit Kit 48 In. 2100 Lumen Include 1x18W 4000K Lamp
USE4RB502T8L11X1LI18W40	5" Strip Retrofit Kit 48 In. 4200 Lumen Include 2x18W 4000K Lamp
USE8RB421X2T8L11X1LI18W40	4.25" Strip Retrofit Kit 96 In. 4200 Lumen Include 2x18W 4000K Lamp
USE8RB422X2T8L11X1LI18W40	4.25" Strip Retrofit Kit 96 In. 8400 Lumen Include 4x18W 4000K Lamp
USE8RB501X2T8L11X1LI18W40	5" Strip Retrofit Kit 96 In. 4200 Lumen Include 2x18W 4000K Lamp
USE8RB502X2T8L11X1LI18W40	5" Strip Retrofit Kit 96 In. 8400 Lumen Include 4x18W 4000K Lamp

Change 40 to 35 or 50 for different Kelvin. Change Lamp Wattage to 15W on 2FT or 15W on 4FT

Consult for Fixtures Wired for LED T8 Lamps with Lamps Sold Separately

How To Add Emergency to X1LED



Separate LED Array added for Emergency.



KEYSTONE KT-EMERG-LED-12-1200-K1 LED EMERGENCY LIGHTING KIT

12W Constant Wattage - Ballast Battery Backup - Damp Location - 120-277V

Includes driver, separately housed 1200mAh Ni-Cd battery and 0.7" x 8" 1200 Lumen LED module for complete emergency lighting installations. When AC power fails, the driver will power the LED for a minimum of 90 minutes emergency illumination. Easy installation in existing LED or fluorescent fixtures with wiring diagrams and labels on all parts. Mounting hardware included. Full 5 year warranty on all components. Output Current 1000 mA-200mA - Output Voltage 12 ~41 Vdc

To order, add EMKT12 to end of X1LED item number

UNIVERSAL STRIP RETROFIT KIT

Choice of Reflectors or Ballast Cover

For ballast cover, choose strip width 4.25" or 5"

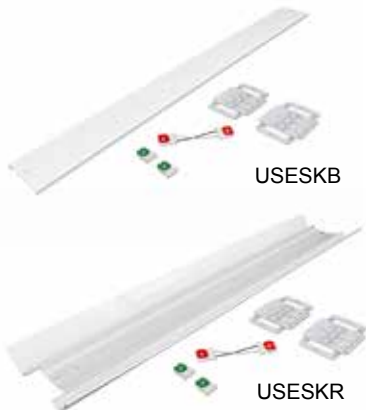

For enhanced light output add a mirrored specular reflector (M20) or white reflector (W10)

Universal socket bar USESKRUSB is ideal to retrofit 4.25" to 5" strips with either reflector or ballast cover.

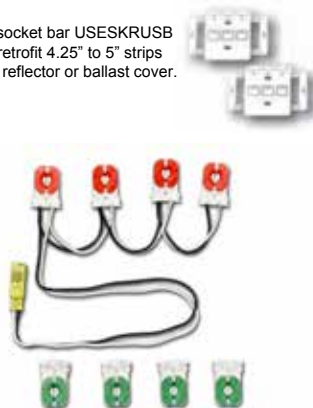

ITEM NO.	DESCRIPTION
USESKB132B4L11X1LI18W40	4.25" Strip Retrofit Kit 48". 2100 Lumen Included 1x18W 4000K Lamps
USESKB232B4L11X1LI18W40	4.25" Strip Retrofit Kit 48". 4200 Lumen Included 2x18W 4000K Lamps
USESKB1328B4L11X1LI18W40	4.25" Strip Retrofit Kit 96". 4200 Lumen Included 2x18W 4000K Lamps
USESKB2328B4L11X1LI18W40	4.25" Strip Retrofit Kit 96". 8400 Lumen Included 4x18W 4000K Lamps
USESKB132B5L11X1LI18W40	5" Strip Retrofit Kit 48". 2100 Lumen Included 1x18W 4000K Lamps
USESKB232B5L11X1LI18W40	5" Strip Retrofit Kit 48". 4200 Lumen Included 2x18W 4000K Lamps
USESKB1328B5L11X1LI18W40	5" Strip Retrofit Kit 96". 8400 Lumen Included 2x18W 4000K Lamps
USESKB2328B5L11X1LI18W40	5" Strip Retrofit Kit 96". 4200 Lumen Included 4x18W 4000K Lamps
USESKR132W10L11X1LI18W40	Strip Reflector Enhanced White Kit 48" 2100 Lumen Included 1x18W 4000K Lamp
USESKR232W10L11X1LI18W40	Strip Reflector Enhanced White Kit 48" 4100 Lumen Included 2x18W 4000K Lamp
USESKR1328W10L11X1LI18W40	Strip Reflector Enhanced White Kit 96" 4200 Lumen Included 2x18W 4000K Lamp
USESKR2328W10L11X1LI18W40	Strip Reflector Enhanced White Kit 96" 8400 Lumen Included 4x18W 4000K Lamp
USESKR132M20L11X1LI18W40	Strip Reflector Mirror Kit 48" 2100 Lumen Included 1x18W 4000K Lamp
USESKR232M20L11X1LI18W40	Strip Reflector Mirror Kit 48" 4100 Lumen Included 2x18W 4000K Lamp
USESKR1328M20L11X1LI18W40	Strip Reflector Mirror Kit 96" 4200 Lumen Included 2x18W 4000K Lamp
USESKR2328M20L11X1LI18W40	Strip Reflector Mirror Kit 96" 8400 Lumen Included 4x18W 4000K Lamp
USESKRUSB	

Change 40 to 35 or 50 for different Kelvin. Change Lamp Wattage to 15W on 2FT or 15W on 4FT

UL Listed with all Options and Accessories.

Optional Dimming Options

The 4 FT. lamps are available with a dimming option. Specially designed dimming lamps require an external driver that runs up to 4 lamps. Dimming driver is installed in the fixture with dimming lamps to dim with 0-10V to 10%

For Dimmable Version - Change X1 to JLDMMV and LN18W to LN18D

Example: Item No. USE131A432JLDMMVLN18D40K 0-10V Dimming



For Large Quantities, Call For Quote



5X5 WALL MOUNT FIXTURE 4 FT.

ITEM NO.	DESCRIPTION
USE55WM232XLLN15W40	4FT Wall 4400 Lumen 2 x 15W LED T8 4000K Lamps Included

STAIRWELL 4 FT. WITH ULTRASONIC SENSOR

ITEM NO.	DESCRIPTION
USEWM55U5232XLLN15W40	4FT Wall 4400 Lumen 2 x 15W LED T8 4000K Lamps Included

1 Light on Always, 1 Light on Sensor. LED Array Fixtures available with High/Low Microwave Sensor

ADD A MOTION SENSOR & GET A 10 YEAR WARRANTY ON XLLED LAMPS

4X4 LINEAR WALL MOUNT



ITEM NO.	DESCRIPTION
USELW44WSF117XLWHLN9W40	4" x 24" 1400 Lumen Pendant w/ Cable Kit 1 x 9W LED T8 4000 Lamps Included
USELW44WSF217XLWHLN9W40	4" x 24" 2800 Lumen Pendant w/Cable Kit 2 x 9W LED T8 4000 Lamps Included
USELW44WSF132XLWHLN15W40	4" x 48" 2200 Lumen Pendant w/Cable Kit 1 x 15W LED T8 4000 Lamps Included
USELW44WSF232XLWHLN15W40	4" x 48" 4400 Lumen Pendant w/Cable Kit 2 x 15W LED T8 4000 Lamps Included
USELW44WSF1328XLWHLN15W40	4" x 96" 4400 Lumen Pendant w/Cable Kit 2 x 15W LED T8 4000 Lamps Included
USELW44WSF2328XLWHLN15W40	4" x 96" 8800 Lumen Pendant w/Cable Kit 4 x 15W LED T8 4000 Lamps Included

Change 40K to 35K or 50K for different Kelvin. Change Lamp Wattage to 7W on 2FT or 18W on 4FT
 Change SF (Snap Fit Frosted Lens) to MW for Matte White Regressed Lens
 Change WH to BK (Black), IR (Iron), SL (Silver) or BR (Bronze) 48" and 96"
 For Baffled Louve , Change MW to BL

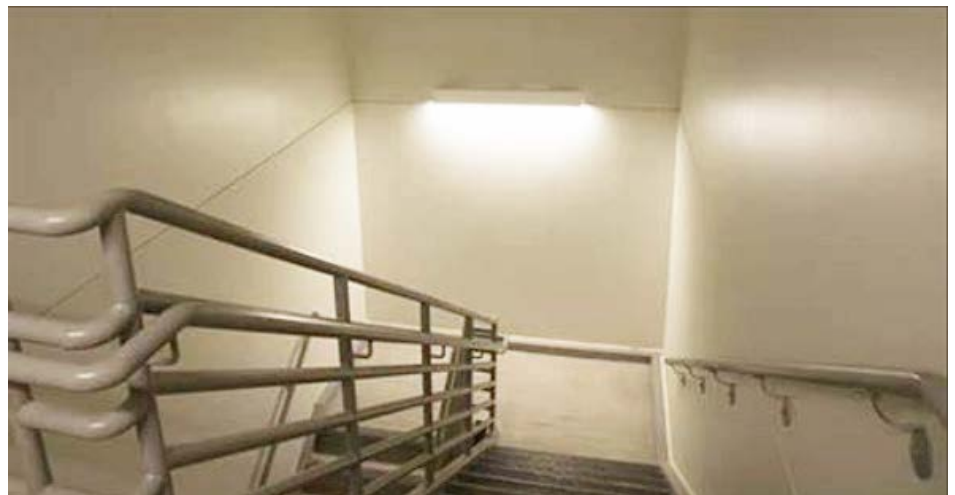

For Large Quantities, Call or Email for Quote

Special red sockets to identify fixtures made for LED T8 lamps.

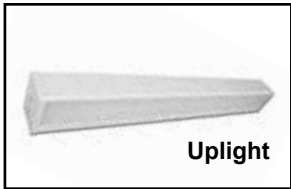

BED LIGHT (Direct and Indirect Light)

ITEM NO.	DESCRIPTION
USE215A1U1D17DFX1LN15W40	24" Direct/Indirect 3400 Lumens 2x15W LED T8 4000K Lamps Included
USE215A1U1D32DFX1LN18W40	48" Direct/Indirect 3400 Lumens 2x18W LED T8 4000K Lamps Included
USE215A1U2D17DFX1LN15W40	24" Direct/Indirect 5100 Lumens 3x15W LED T8 4000K Lamps Included
USE215A1U2D32DFX1LN18W40	48" Direct/Indirect 6300 Lumens 3x18W LED T8 4000K Lamps Included
USE215A2U1D17DFX1LN15W40	24" Direct/Indirect 5100 Lumens 3x15W LED T8 4000K Lamps Included
USE215A2U1D32DFX1LN18W40	48" Direct/Indirect 6300 Lumens 3x18W LED T8 4000K Lamps Included
USE215A2U2D17DFX1LN15W40	24" Direct/Indirect 6800 Lumens 4x15W LED T8 4000K Lamps Included
USE215A2U2D32DFX1LN18W40	48" Direct/Indirect 8400 Lumens 4x18W LED T8 4000K Lamps Included

Change 40 to 35 or 50 for different Kelvin. Change Lamp Wattage to 15W on 2FT or 15W on 4FT Add SW4

Add PC4 to switch up and down separately.

Consult for Fixtures Wired for LED T8 Lamps with Lamps Sold Separately

For Emergency Option, see page 88.

For Dimmable Version - Change X1 to JLDMMV and LN18W to LN18D

Example: Item No. USE131A432JLDMMVLN18D40K 0-10V Dimming



For Large Quantities, Call For Quote

Special red sockets to identify fixtures made for LED T8 lamps.



Add PC4 Sensor to switch up and down separately.



STAIRWAY WALL LIGHTS (Direct & Indirect Lighting)

ITEM NO.	DESCRIPTION
USE2WM1U171D17DIXLN9W40K	24" Direct/Indirect 2800 Lumens 2 x 9W LED T8 4000K Lamps Included
USE4WM1U321D32DIXLN15W40K	48" Direct/Indirect 4400 Lumens 2 x 15W LED T8 4000K Lamps Included
USE2WM1U172D17DIXLN9W40K	24" Direct/Indirect 4200 Lumens 3 x 9W LED T8 4000K Lamps Included
USE4WM1U322D32DIXLN15W40K	48" Direct/Indirect 6600 Lumens 3 x 15W LED T8 4000K Lamps Included
USE2WM12U171D17DIXLN9W40K	24" Direct/Indirect 4200 Lumens 3 x 9W LED T8 4000K Lamps Included
USE4WM2U321D32DIXLN15W40K	48" Direct/Indirect 6600 Lumens 3 x 15W LED T8 4000K Lamps Included
USE2WM2U172D17DIXLN9W40K	24" Direct/Indirect 5600 Lumens 4 x 9W LED T8 4000K Lamps Included
USE4WM2U322D32DIXLN15W40K	48" Direct/Indirect 8800 Lumens 2 x 15W LED T8 4000K Lamps Included

ENCLOSURES/ALL WEATHER

VAPOR TIGHT ENCLOSURES LED LAMPS AND LED ARRAYS



ITEM NO.	DESCRIPTION
USEVTECL232XLN15W40K	4FT Enclosure w/ Clear Lens 4400 Lumens 2 x 15W LED T8 4000K Lamps Included
USEVTECL332XLN15W40K	4FT Enclosure w/Clear Lens 6600 Lumens 3 x 15W LED T8 4000K Lamps Included
USEVTELB8232XLN15W40K	8FT Enclosure w/Linear Ribbed Lens 8800 Lumen 4 x 15W LED T8 4000K Lamps Included

Change 40K to 35K or 50K for different Kelvin. Change Lamp Wattage to 9W on 2FT or 18W on 4FT
 Consult for different lens options and sensors
 Change CL lens on 4FT to LB (Linear Ribbed) to match 8FT lens

WIDE BODY GARAGE LIGHT



ITEM NO.	DESCRIPTION
USEWBGL332SMB3XLN15W40K	4FT Deep Clear Enclosure 6600 Lumens for Wide Distribution 3 x 15W LED T8 4000K Lamps Included. Surface Mount Brackets
USEWBGL332SMB3XLN15W40K-MDT4	4FT Deep Clear Enclosure 6600 Lumens for Wide Distribution 3 x 15W LED T8 4000K Lamps Included. Surface Mount Brackets and Occupancy Sensor Included. Occupancy Sensor Wired to Two Wide Area Lamps

Change 40K to 35K or 50K for different Kelvin. Change Lamp Wattage to 7W on 2FT or 18W on 4FT
 Consult for different lens options and sensors
 Change CL lens on 4FT to LB (Linear Ribbed) to match 8FT lens

For Large Quantities, Call or Email for Quote

SPILL RING BATH



ITEM NO.	DESCRIPTION
USEHOTBD217X1SNLN15W40	2ft. Wall 3400 Lumen 2x15W LED T8 4000K Lamps Included
USEHOTBD232X1SNLN18W40	4ft. Wall 4200 Lumen 2x18W LED T8 4000K Lamps Included

Change 40 to 35 or 50 for different Kelvin. Change Lamp Wattage to 15W on 2FT or 15W on 4FT

END CAP BATH



ITEM NO.	DESCRIPTION
USEVAN217X1LN15W40 (AL, SW, IV, BM, TO, WM)	2ft. Wall 3400 Lumen 2x15W LED T8 4000K Lamps Included
USEVAN232X1LN18W40 (AL, SW, IV, BM, TO, WM)	4ft. Wall 4200 Lumen 2x18W LED T8 4000K Lamps Included

Change 40 to 35 or 50 for different Kelvin. Change Lamp Wattage to 15W on 2FT or 15W on 4FT

WALL PUFF



ITEM NO.	DESCRIPTION
USEWPU217X1LN15W40	2ft. Wall 3400 Lumen 2x15W LED T8 4000K Lamps Included
USEWPU232X1LN18W40	4ft. Wall 4200 Lumen 2x18W LED T8 4000K Lamps Included

Change 40 to 35 or 50 for different Kelvin. Change Lamp Wattage to 15 W on 2FT or 15W on 4FT

LED T8 LAMPS



LED T8 LAMP CHOICES

ITEM NO.	DESCRIPTION
USELED24T815W1700LRK35K	LED T8 Lamp, Instafit or Bypass, 24In., 15W 1700 Lumen 3500
USELED24T815W1700LRK40K	LED T8 Lamp, Instafit or Bypass, 24In., 15W 1700 Lumen 4000
USELED24T815W1700LRK50K	LED T8 Lamp, Instafit or Bypass, 24In., 15W 1700 Lumen 5000

ITEM NO.	DESCRIPTION
USELED48T815W1800LRK35K*	LED T8 Lamp, Instafit or Bypass, 48In., 15W 1800 Lumen 3500
USELED48T815W1800LRK40K*	LED T8 Lamp, Instafit or Bypass, 48In., 15W 1800 Lumen 4000
USELED48T815W1800LRK50K*	LED T8 Lamp, Instafit or Bypass, 48In., 15W 1800 Lumen 5000
USELED48T818W2100LRK35K	LED T8 Lamp, Instafit or Bypass, 48In., 18W 2100 Lumen 3500
USELED48T818W2100LRK40K	LED T8 Lamp, Instafit or Bypass, 48In., 18W 2100 Lumen 4000
USELED48T818W2100LRK50K	LED T8 Lamp, Instafit or Bypass, 48In., 18W 2100 Lumen 5000



Consult for U-Bend, Dimmable and other T8 LED Lamp Options

Consult for Fixtures Wired for LED T8 Lamps with Lamps Sold Separately

About T8 LED Lamps

Our T8 LED lamps are available in 2 or 4 ft. sizes in different wattages, lumens and color temperature options.

- 50,000 Hour Life with 5 Year Warranty
- Beam Angle 140 Degree
- Aluminum Base and Aluminum Housing with Glass Cover
- Operating Temperature: -20°C to 50°C
- Color Temperature: 3500K, 4000K, 5000K
- G13 Pins (Same as Fluorescent Linear T8 Bipins)
- AC100 - 277V without Ballast
- Single Ended Power

US Energy Services, Inc.

EXIT SIGNS

COMPACT LED EXIT SIGN



ITEM NO.	DESCRIPTION
USEEZRXTEU2GWEM	Rounded EXIT, SF/DF, Green, Backup
USEEZRXTEU2RWEM	Rounded EXIT, SF/DF, Red, Battery Backup

THIN THERMOPLASTIC EXIT SIGN



ITEM NO.	DESCRIPTION
USEEZXTEU2GW	LED Exit AC Only Sgl/DbI Face Univ. Green Letters, White Housing, 120/277V
USEEZXTEU2GWEM	LED Exit w/Battery Backup Sgl/DbI Face Univ. Green Letters White Housing, 120/277V
USEEZXTEU2GWEMRC	LED Exit w/Battery Backup Sgl/DbI Face Univ. Green Letters White Housing, Remote Capable 120/277V
USEEZXTEU2RW	LED Exit AC Only Sgl/DbI Face Univ. Red Letters, White Housing, 120/277V
USEEZXTEU2RWEM	LED Exit w/Battery Backup Sgl/DbI Face Univ. Red Letters, White Housing, 120/277V
USEEZXTEU2RWEMRC	LED Exit w/Battery Backup Sgl/DbI Face Univ. Red Letters, White Housing, Remote Capable 120/277V

THIN DIE-CAST LED EXIT SIGN



ITEM NO.	DESCRIPTION
USEKZXTEU1GAEM	Thin Die Cast, SF, Green, Battery Backup, Al face, Al body
USEKZXTEU1RAEM	Thin Die Cast, SF, Red, Battery Backup, Al face, Al body

THERMOPLASTIC LED EDGELIT EXIT SIGN



ITEM NO.	DESCRIPTION
USEPLELRXTEU1RCAEM	Plastic Edge-Lit, SF, Red, Clear, Silver Housing, Battery Backup
USEPLELRXTEU1RCWEM	Plastic Edge-Li, SF, Red, White Housing, Battery Backup

ALUMINUM LED EDGELIT EXIT SIGN



ITEM NO.	DESCRIPTION
USEELXTEU1GCAEM	Edge-Lit LED Exit Battery Backup, Single Face Green/Clear 120/277V
USEELXTEU1RCAEM	Edge-Lit LED Exit Battery Backup, Single Face Red/Clear, 120/277V
USEELXTERPANEL USEELXTEGPANEL	Edge-Lit LED Exit Single Face Green/Clear, 120/277V

For version made in USA, Add "US" to the prefix of the item number

US Energy Services, Inc.

Ph: 512.407.8858 • Email Info Requests and Orders to: Sales@us-energyservices.com
www.us-energyservices.com

EXIT SIGNS

RECESSED ALUMINUM LED EDGELIT EXIT SIGN



ITEM NO.	DESCRIPTION
USERELZXTE1GCAEM	Recessed Edge-Lit Exit Sign, Battery Backup, Single Face, BELOW ACCESS, Green/Clear, 120/277V
USERELZXTE1RCAEM	Recessed Edge-Lit Exit Sign, Battery Backup, Single Face, BOTTOM ACCESS, Red/Clear, 120/277V
USERELZXTE2GMAEM	Recessed Edge-Lit Exit Sign, Battery Backup, Double Face, BELOW ACCESS, Green/Mirror, 120/277V
USERELZXTE2RMAEM	Recessed Edge-Lit Exit Sign, Battery Backup, Double Face, BOTTOM ACCESS, Red/Mirror, 120/277V

COMPACT WET LOCATION LED EXIT SIGN



ITEM NO.	DESCRIPTION
USEWLEZXTEU1GGEMCW	Wet location Exit sign, single face, green letters, gray housing, white face plate, battery back up, cold weather incl'd
USEWLEZXTEU1RGEMCW	Wet location Exit sign, single face, red letters, gray housing, white face plate, battery back up, cold weather incl'd
USEWLEZXTEU2GGEMCW	Wet location Exit sign, double face, green letters, gray housing, white face plate, battery back up, cold weather incl'd
USEWLEZXTEU2RGEMCW	Wet location Exit sign, double face, red letters, gray housing, white face plate, battery back up, cold weather incl'd

For version made in USA, Add "US" to the prefix of the item number and use the US column for pricing.

US Energy Services, Inc.

Ph: 512.407.8858 • Email Info Requests and Orders to: Sales@us-energyservices.com
www.us-energyservices.com

COMBO EXIT/EMERGENCY

ALL LED EXIT & EMERGENCY COMBO



ITEM NO.	DESCRIPTION
USELEDCXTEU2RW	White LED Combo, SF/DF, Red, White
USELEDCXTEU2RWRC	White LED Combo, SF/DF, Red, White, Remote Capable

LED EXIT & INCANDESCENT EMERGENCY COMBO



ITEM NO.	DESCRIPTION
USECXTEU2GW	COMBO LED Exit/Emerg. Light Sgl/Dbf Face Green Letters White Housing, 120/277V
USECXTEU2GWRC	COMBO LED Exit/Emerg. Light Sgl/Dbf Green Letters, white housing, w/Remote Capability, 120/277V
USECXTEU2RW	COMBO LED Exit/Emerg. Light Sgl/Dbf Face Red Letters White Housing, 120/277V
USECXTEU2RWRC	COMBO LED Exit/Emerg. Light Sgl/Dbf Red Letters, white housing, w/Remote Capability, 120/277v

LOW PROFILE ALL LED EXIT & EMERGENCY COMBO



ITEM NO.	DESCRIPTION
USECEU3RW	Low Profile All LED Exit & Emergency Combo, Red, White Housing
USECEU3GW	Low Profile All LED Exit & Emergency Combo, Green, White Housing

LIGHTPIPE LED EXIT & EMERGENCY COMBO



ITEM NO.	DESCRIPTION
USECLPU2GWRC	Pipe Combo, SF/DF, Green, White, Remote Capable
USECLPU2RWRC	Pipe Combo, SF/DF, Red, White, Remote Capable

For version made in USA. Add "US" to the prefix of the item number and use the US column for pricing.

US Energy Services, Inc.

Ph: 512.407.8858 • Email Info Requests and Orders to: Sales@us-energyservices.com
www.us-energyservices.com

EMERGENCY



LED EMERGENCY UNIT

ITEM NO.	DESCRIPTION
USELEDR1	LED Emergency Light, White
USELEDR1B	LED Emergency Light, black
USELEDR1SDT	LED Emergency Light, White, SDT



REMOTE CAPABLE LED EMERGENCY UNIT

ITEM NO.	DESCRIPTION
USELEDR5HO	LED Emergency Light, White, Remote Capable
USELEDR5HOSDT	LED Emergency Light, White, Remote Capable, SDT



ADJUSTABLE OPTICS LED EMERGENCY UNIT

ITEM NO.	DESCRIPTION
USELEDR2	LED Emergency Light, White, 120/277
USELEDR2B	LED Emergency Light, Black, 120/277



SEMI-RECESSED MR-16 EMERGENCY UNIT

ITEM NO.	DESCRIPTION
USERMR16	2 Lamp Emergency Fixture, White Housing, 120/277V, Ultra bright MR-16 lamps
USERMR16LED	2 Lamp Emergency Fixture, White Housing, 120/277V, High Output 3.3w LED lamps



R-1 EMERGENCY UNIT

ITEM NO.	DESCRIPTION
USER1	2 Head Emergency Fixture w/Battery, White Housing, 120/277V



R-2 EMERGENCY UNIT

ITEM NO.	DESCRIPTION
USER2	Twin Lens Emergency Fixture w/Battery, White Housing, 120/277V



DXR EMERGENCY UNIT

ITEM NO.	DESCRIPTION
USEDXR125	50 watt 12 Volt Heavy duty emergency lighting unit with remote capacity. (50 watts for 90 min.), 120/277V
USEDXR610	100 watt 6 Volt Heavy duty emergency lighting unit with remote capacity. (100 watts for 90 min.), 120/277V

EMERGENCY - WET LOCATION

WET LOCATION SEMIRECESSED MR-16 EMERGENCY UNIT



ITEM NO.	DESCRIPTION
USERMR16WP	2 Lamp, Weatherproof Emergency Fixture, Gray Housing, 120/277V, Ultra bright MR-16 lamps
USERMR16WPLED	2 Lamp, Weatherproof Emergency Fixture, Gray Housing, 120/277V, High Output 3.3w LED lamps

DECORATIVE OUTDOOR LED AC/EMERGENCY UNIT



ITEM NO.	DESCRIPTION
USEDBELACEMHLBRSDTPC	Outdoor teardrop LED Die Cast , AC and EM operation, High lumen output, SDT (standard), includes photo cell, Bronze
USEDBELACEMHLBRSDTCWPC	Outdoor teardrop LED Die Cast , AC and EM operation, High lumen output, SDT (standard), includes photo cell, Cold Weather, Bronze



WET LOCATION REMOTE CAPABLE LED EMERGENCY UNIT

ITEM NO.	DESCRIPTION
USELEDTFX2	LED Wet Location 2 Head Emergency Light Unit, COLD WEATHER HEATER INCLUDED, 120/277V

REMOTE HEADS FOR EXITS & EMERGENCY

(See Spec Sheet for the Right Item for Your Application)



USERH2



USERHLED1

USERHLED1PWP



USERHLED2



USERHLED2PWP

ITEM NO.	DESCRIPTION
USERH26V5.W	Dual head Indoor remote 5.4 Watts
USERH2WP6V7.2W	Double head weather proof remote 5.4 Watts
USERHLED1CLPCXTE(9.6V)	LED Combo Remote Head, Single, Indoor
USERHLED1R1(3.6V)	LED R1 Remote Head, Single, Indoor
USERHLED1MV	LED Multi-Volt (3.6v/6v/9.6v/12v) Remote Head, Single, Indoor
USERHLED1PWPCLPCXTE	LED Combo Remote Head, Plastic, Single, Wet Location
USERHLED1WPCLPCXTE	LED Combo Remote Head, Single, Wet Location
USERHLED1PWPR1	LED R1 Remote Head, Plastic, Single, Wet Location
USERHLED1WPR1	LED R1 Remote Head, Single, Wet Location
USERHLED2CLPCXTE	LED Combo Remote Head, Double
USERHLED2R1	LED R1 Remote Head, Double
USERHLED2MV	LED Multi-Volt (3.6v/6v/9.6v/12v) Remote Head, Dual, Indoor
USERHLED2PWPCLPCXTE	LED Combo Remote Head, Plastic, Double, Wet Location
USERHLED2WPCLPCXTE	LED Combo Remote Head, Double, Wet Location
USERHLED2PWPR1	LED R1 Remote Head, Plastic, Double, Wet Location
USERHLED2WPR1	LED R1 Remote Head, Double, Wet Location

For other options and accessories, see specification sheets.

STATEMENT OF LIMITED WARRANTY

A. US Energy Services, Inc. warrants that all of its indoor and outdoor light emitting diode (LED) fixtures, including the LED array, LED drivers and integral control devices, are free of defects in workmanship and materials for a period of five (5) years from the date of shipment. Unless otherwise expressly stated in writing, the LED array will be considered defective if a total of 15% or more of the individual light emitting diodes fail to illuminate. US Energy Services reserves the right to determine, in its sole and absolute discretion, whether to repair or replace defective LED fixtures or components. No charge-back, or reimbursement for in-the-field labor or material, or delay in installation, that results from defective products, will be honored, accepted or paid for by US Energy Services, unless expressly authorized in writing by US Energy Services. In no event shall any inside salesperson or outside sales agent of US Energy Services have the authority to bind US Energy Services to any such charge under this Warranty.

SPECIAL **XLLED** BYPASS T8 LAMP WARRANTY

XLLED BYPASS T8 LAMPS SHALL HAVE A WARRANTY OF 5 YEARS UNLESS USED WITH AN OCCUPANCY SENSOR. **XLLED** BYPASS T8 LAMPS SHALL HAVE A 10 YEAR WARRANTY FROM DATE OF PURCHASE ONLY IF THE FIXTURE HAS AN OCCUPANCY SENSOR INSTALLED ON THE FIXTURE OR WALL OR CEILING MOUNTED WITH THE FIXTURE IN THE SAME ROOM. YOU MUST REGISTER THE PROJECT IN WRITING FOR THE 10 YEAR WARRANTY. (NO LABOR IS INCLUDED)

B. This Statement of Limited Warranty applies only when US Energy Services product(s) are installed in applications in which ambient temperatures are within the range of specified operating temperatures and are operated within the electrical values shown on the ballast or LED driver Label. US Energy Services will not be responsible for any failure of any US Energy Services product(s) that results from external causes such as: acts of nature; physical damage; exposure to adverse or hazardous chemical or other substances; use of reactive cleaning agents and/or harsh chemicals to clean US Energy Services product(s); environmental conditions; vandalism; fire; power failure, improper power supply, power surges or dips, and/or excessive switching; induced vibration; animal or insect activity; fault or negligence of purchaser, any end user of US Energy Services product(s) and/or any third party not engaged by US Energy Services improper or unauthorized use, installation, handling, storage, alteration, maintenance or service, including failure to abide by any product classifications or certifications, or failure to comply with any applicable standards, codes, recommendations, product specification sheets, or instructions of US Energy Services; use of US Energy Services product(s), processes or materials supplied by any end user or third party; or any other occurrences beyond US Energy Services reasonable control. US Energy Services will not be responsible for any substantial deterioration in fixture paint finish that is caused by failure to clean, inspect, handle or maintain.

C. Occupancy Sensors, Emergency Battery Packs, Exit Signs, Emergency Fixtures and poles are covered by a separate manufacturer's warranties. Therefore, each US Energy Services customer or end-user must timely notify US Energy Services or the manufacturer directly, if directed to do so by US Energy Services in order to preserve the applicable manufacturer's warranty available under this provision. **CUSTOMER OR END-USER FAILURE TO TIMELY COMPLY WITH THIS NOTICE PROVISION MAY VOID THE MANUFACTURER WARRANTY. ALL WARRANTY ISSUES MUST BE SENT TO US ENERGY SERVICES IN WRITING IN A TIMELY MANNER. All Warranty Claims must be reported in writing within 30 days of failure (Freight Not Included)**

D. IN NO EVENT SHALL US ENERGY SERVICES, INC. BE RESPONSIBLE TO REPAIR OR REPLACE ANY PRODUCT THAT WAS NOT USED FOR ITS INTENDED PURPOSE OR THAT WERE INSTALLED OR MODIFIED IN ANYWAY NOT IN ACCORDANCE TO MANUFACTURERS EXPRESS WRITTEN INSTRUCTION.

E. NO AGENT, EMPLOYEE OR REPRESENTATIVE OF US ENERGY SERVICES, INC. HAS ANY AUTHORITY TO BIND US ENERGY SERVICES TO ANY AFFIRMATION, REPRESENTATION OR WARRANTY CONCERNING PRODUCTS SOLD BY US ENERGY SERVICES, INC. UNLESS AUTHORIZED TO DO SO IN WRITING.

Pricing can fluctuate based on supply and availability of products. Please contact us for updated pricing.

We reserve the right to change designs, materials, LEDs and finishes in any way that will not alter installed appearance or reduce function and performance.

For our website and complete LED Buyers Guide, Please use QR Code Below



US Energy Services, Inc.

Ph: 512.407.8858 • Email Info Requests and Orders to: Sales@us-energyservices.com
www.us-energyservices.com



US Energy Services, Inc.

512.407.8858

sales@us-energyservices.com

www.us-energyservices.com

LED BUYERS GUIDE

Practical LED

Specification Grade Products at Value Pricing

2025

UPDATED PRODUCTS

For Large Quantities, Call or Email for Quote

Check our local warehouse for in-stock specials & close-outs



Now with New Budget Pricing!